

NOTES TO A/E:

1. THE PoE INJECTORS SHALL BE LOCATED WITHIN THE HEADEND EQUIPMENT RACK(S) OR NODE CABINETS.

WIRING FOR INDOOR CAMERA RUN LESS THAN 300 FEET

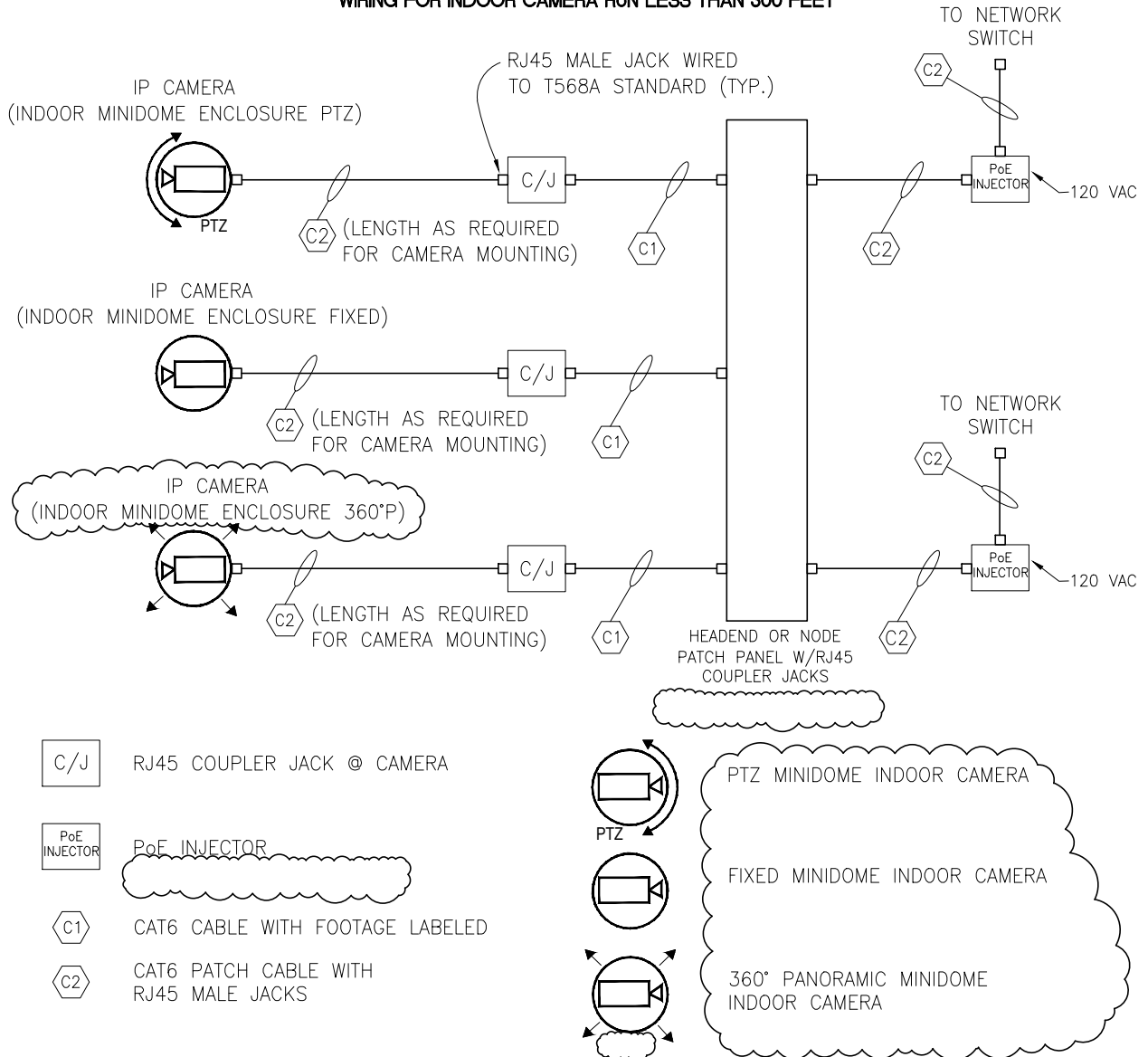

C/J RJ45 COUPLER JACK @ CAMERA

PoE INJECTOR

C1 CAT6 CABLE WITH FOOTAGE LABELED

C2 CAT6 PATCH CABLE WITH RJ45 MALE JACKS

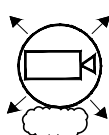
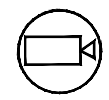
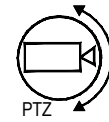

PTZ MINIDOME INDOOR CAMERA

FIXED MINIDOME INDOOR CAMERA

360° PANORAMIC MINIDOME INDOOR CAMERA

Detail: **CCTV SYSTEM - WIRING FOR INDOOR CAMERA RUN LESS THAN 300 FEET**

CAD File: \usps\library\details\P5-7-0a.dwg

Scale: NTS

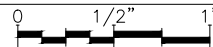

Fac. Ch. Sect. Para. Detail

P5-7-0 a

Last Revised: 10/1/2023

NOTES TO A/E:

1. THIS DETAIL IS TYPICAL FOR R&A PROJECTS ONLY. WHEN ADDING OR REPLACING CAMERAS TO AN EXIST'G. CCTV SYSTEM, THE EXIST'G. CAT. 5e/6 INTERIOR CAMERA CABLE RUNS IN EXCESS OF 300 FT. AND NO LONGER THAN 800 FT. IN TOTAL LENGTH MAY BE REUSED IF FIELD TESTED ACCEPTABLE AND EQUIPPED WITH ETHERNET CABLE EXTENDERS.
2. THE ETHERNET CABLE EXTENDERS SHALL BE LOCATED AT THE CAMERA AND WITHIN THE HEADEND EQUIPMENT RACK(S) OR NODE CABINETS.
3. INTERIOR CAMERA CABLE RUNS EXCEEDING 300 FT. TO THE NODE CABINETS OR HEADEND FOR NEW OR TOTAL CCTV UPGRADE PROJECTS SHALL BE FIBER OPTIC TYPE.

WIRING FOR INDOOR CAMERA RUN 300 FEET TO 800 FEET

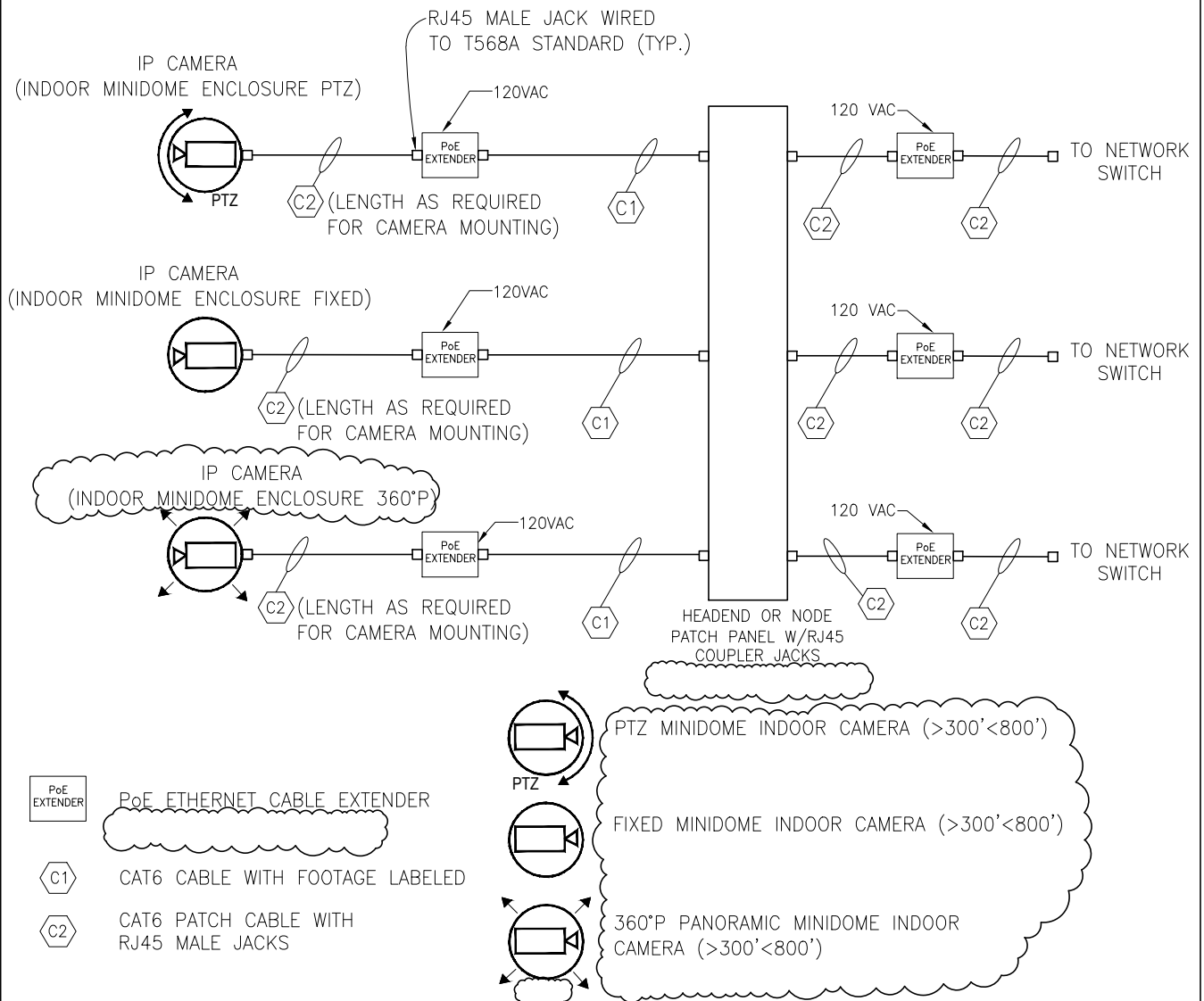

Detail: **CCTV SYSTEM - WIRING FOR INDOOR CAMERA RUN 300 FEET TO 800 FEET (R&A)**

Fac. Ch. Sect. Para. Detail
P5-7-0 b

CAD File: [\usps\library\details\P5-7-0b.dwg](#)

Scale: NTS 0 1/2" 1"

Last Revised: 10/1/2023

NOTES TO A/E:

1. THE SURGE PROTECTION DEVICES SHALL BE LOCATED AT THE CAMERA AND WITHIN THE HEADEND EQUIPMENT RACK(S) OR NODE CABINET.

WIRING FOR EXTERIOR BUILDING WALL MOUNTED CAMERA RUN LESS THAN 300 FEET

NOTE:

EXTERIOR, BUILDING WALL MOUNTED, CAMERAS SERVED BY INTERIOR CABLING SHALL BE WIRED SIMILARLY TO AN INDOOR CAMERA. PROVIDE SURGE PROTECTION AS SHOWN.

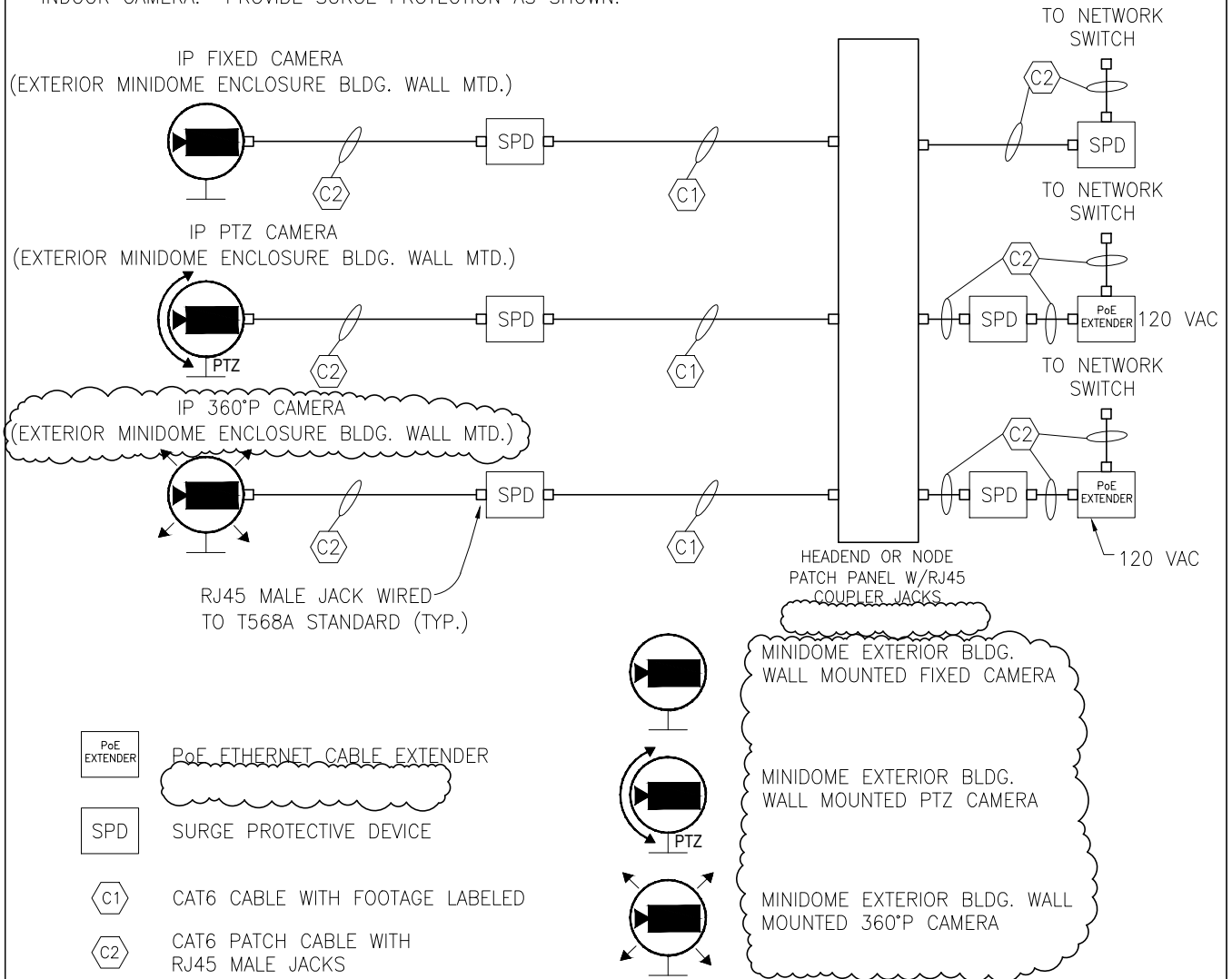

Detail: **CCTV SYSTEM - WIRING FOR BUILDING MOUNTED CAMERA RUN LESS THAN 300 FEET**

Fac. Ch. Sect. Para. Detail
P5-7-0 c

CAD File: `\\usps\library\details\P5-7-0c.dwg`

Scale: **NTS** 0 1/2" 1"

Last Revised: 10/1/2023

NOTES TO A/E:

1. THIS DETAIL IS TYPICAL FOR R&A PROJECTS ONLY. WHEN ADDING OR REPLACING CAMERAS TO AN EXIST'G. CCTV SYSTEM, THE EXIST'G. CAT. 5e/6 INTERIOR CAMERA CABLE RUNS IN EXCESS OF 300 FT. AND NO MORE THAN 800 FT. IN TOTAL LENGTH MAY BE REUSED IF FIELD TESTED ACCEPTABLE AND EQUIPPED WITH ETHERNET CABLE EXTENDERS.
2. INTERIOR CAMERA CABLE RUNS EXCEEDING 300 FT. TO THE NODE CABINETS OR HEADEND FOR NEW OR TOTAL CCTV UPGRADE PROJECTS SHALL BE FIBER OPTIC TYPE.
3. THE ETHERNET CABLE EXTENDERS SHALL BE LOCATED AT THE CAMERA AND WITHIN THE HEADEND EQUIPMENT RACK(S) OR NODE CABINETS.
4. THE SURGE PROTECTION DEVICES SHALL BE LOCATED AT THE CAMERA AND WITHIN THE HEADEND EQUIPMENT RACK(S) OR NODE CABINET.

WIRING FOR EXTERIOR BUILDING WALL MOUNTED CAMERA RUN 300 FEET TO 800 FEET

NOTE:

EXTERIOR, BUILDING WALL MOUNTED, CAMERAS SERVED BY INTERIOR CABLING SHALL BE WIRED SIMILARLY TO AN INDOOR CAMERA. PROVIDE SURGE PROTECTION AS SHOWN.

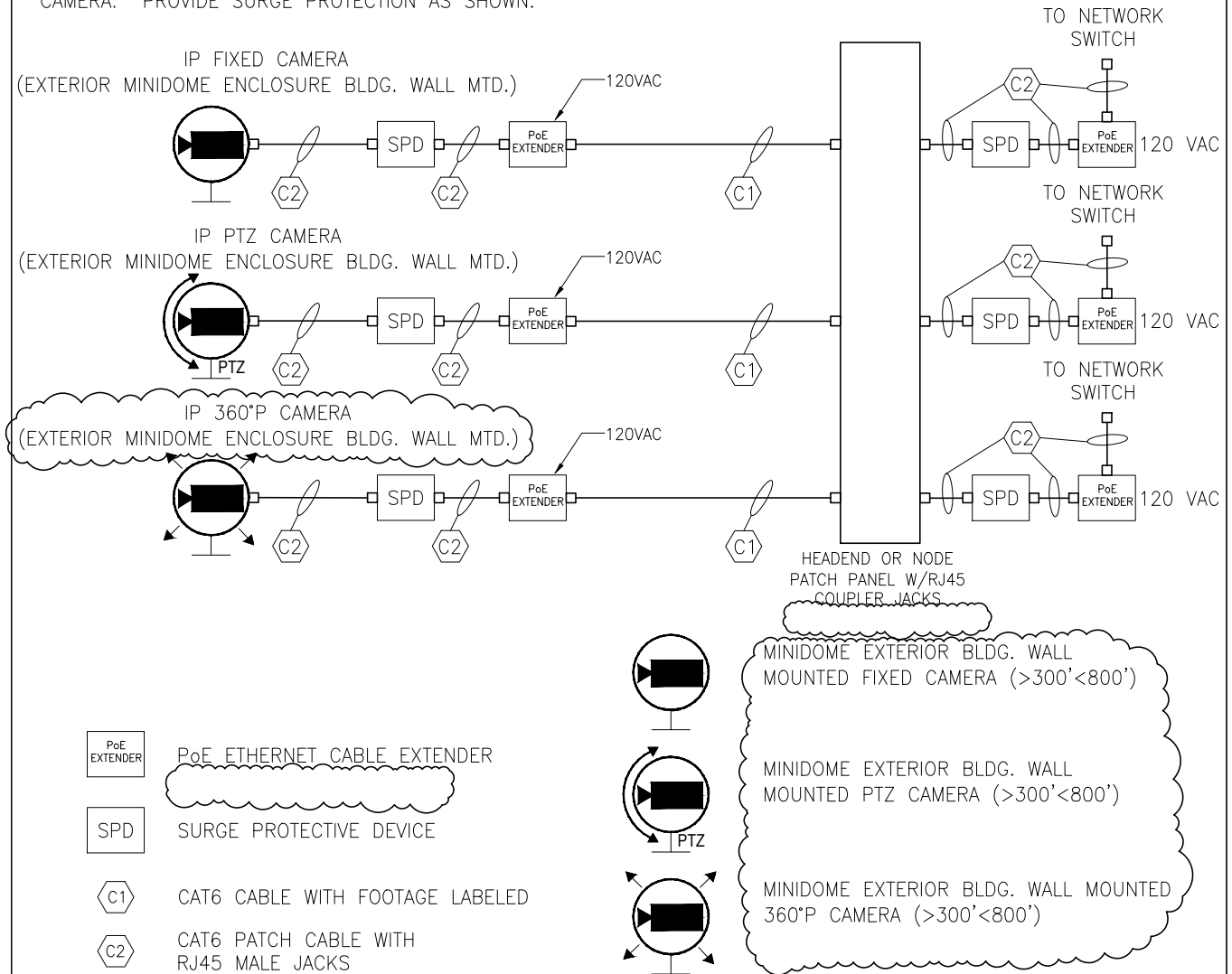

Detail: **CCTV SYSTEM - WIRING FOR BUILDING MOUNTED CAMERA RUN 300 FEET TO 800 FEET (R&A)**

Fac. Ch. Sect. Para. Detail

P5-7-0 d

CAD File: `\\usps\library\details\P5-7-0d.dwg`

Scale: **NTS**

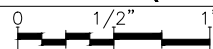

Last Revised: 10/1/2023

NOTES TO A/E:

- RECEPTACLE MOUNTED WITHIN THE NEMA 4 ENCLOSURE SHALL NOT BE "GFCI" TYPE.

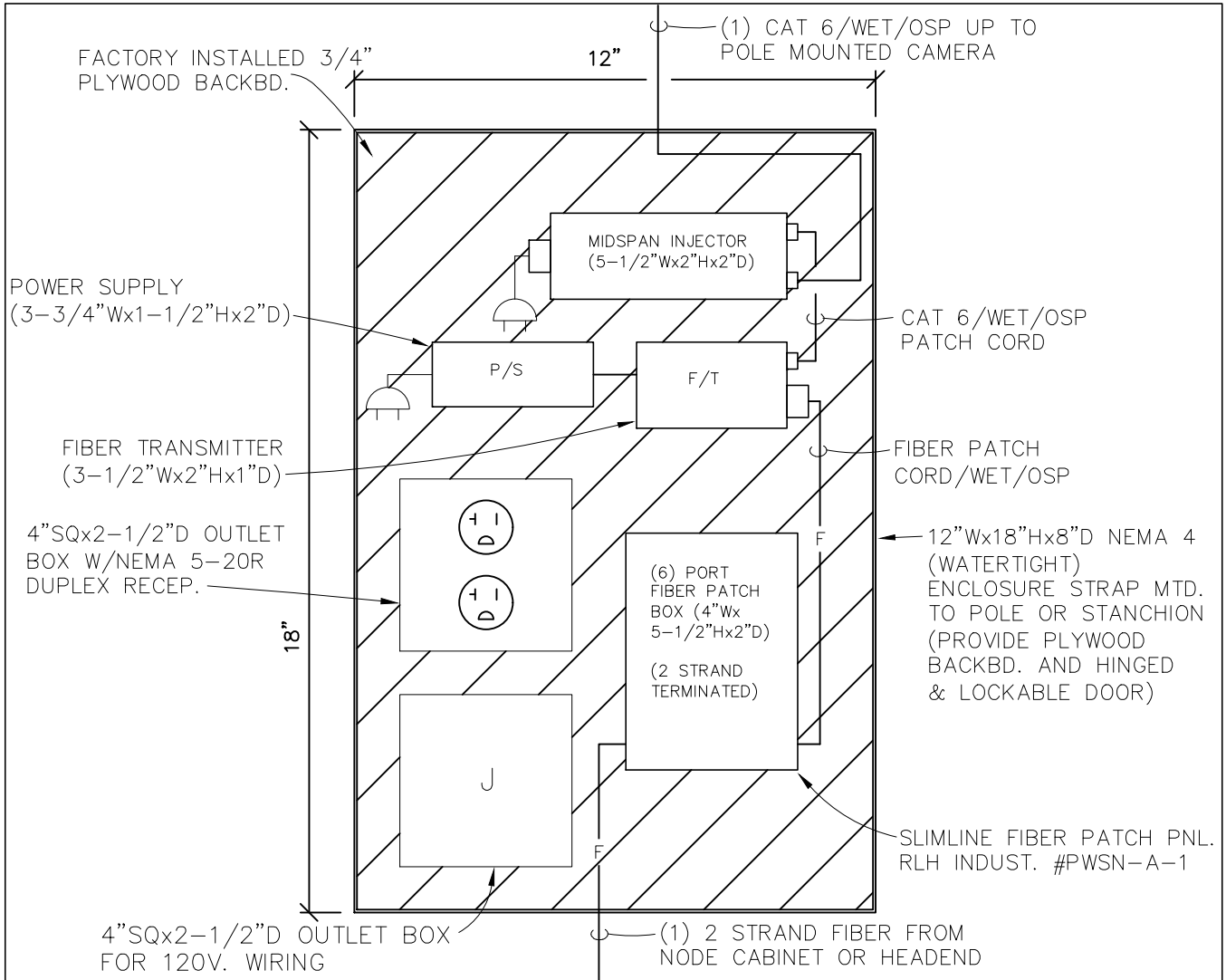

NOTES: ENTERING/EXITING ENCLOSURE

- ENCLOSURE SHALL BE NEMA 4 RATED STAINLESS STEEL OR NONMETALLIC, POLYCARBONATE TYPE.
- ALL COMPONENTS SHALL BE SECURELY FASTENED TO THE BACKBOARD USING FACTORY BRACKETS & APPROPRIATE WOOD SCREWS. USE OF DOUBLE SIDED, ADHESIVE HOOK & LOOP STRAPS IS NOT ACCEPTABLE.
- FIBER TRANSMITTERS SHALL NOT BE SECURED ATOP OF THE INJECTORS.
- PATCH CORDS SHALL BE AS LONG AS NECESSARY FOR THE APPLICATION BUT AS SHORT AS POSSIBLE TO AVOID LARGE CABLE BUNDLES.
- EXCESS CABLE LENGTHS SHALL BE PROPERLY LOOPED AND SECURED USING HOOK & LOOP STRAPS; TIE-WRAPS ARE NOT ACCEPTABLE.
- THE 120 VOLT WIRING ROUTED W/I THE ENCLOSURE SHALL BE CONTAINED IN CONDUIT. OPEN 120 VOLT WIRING IS NOT ACCEPTABLE. PROVIDE 120 VOLT SPD'S (EDCO #FAS-100F @ RECEP.)
- A 6 FT. FIBER OPTIC SERVICE LOOP SHALL BE INSTALLED WITHIN THE ENCLOSURE. SERVICE LOOP SHALL BE INSTALLED SUCH THAT THE MINIMUM BEND RADIUS IS NOT EXCEEDED. ONCE THE FIBER REACHES THE PATCH PANEL THERE SHALL BE NO LESS THAN 3 FEET OF UNSHEATHED FIBER INSTALLED NEATLY IN STORAGE TRAY PRIOR TO INSTALLATION OF FAN-OUT KIT AND TERMINATIONS.

Detail: NEMA 4 EXTERIOR ENCLOSURE - SINGLE CAMERA POLE	Fac. Ch. Sect. Para. Detail P5-7-0 e
	CAD File: \12 standard details\details\P5-7-0e.dwg

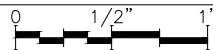

Last Revised: 10/1/2023

NOTES TO A/E:

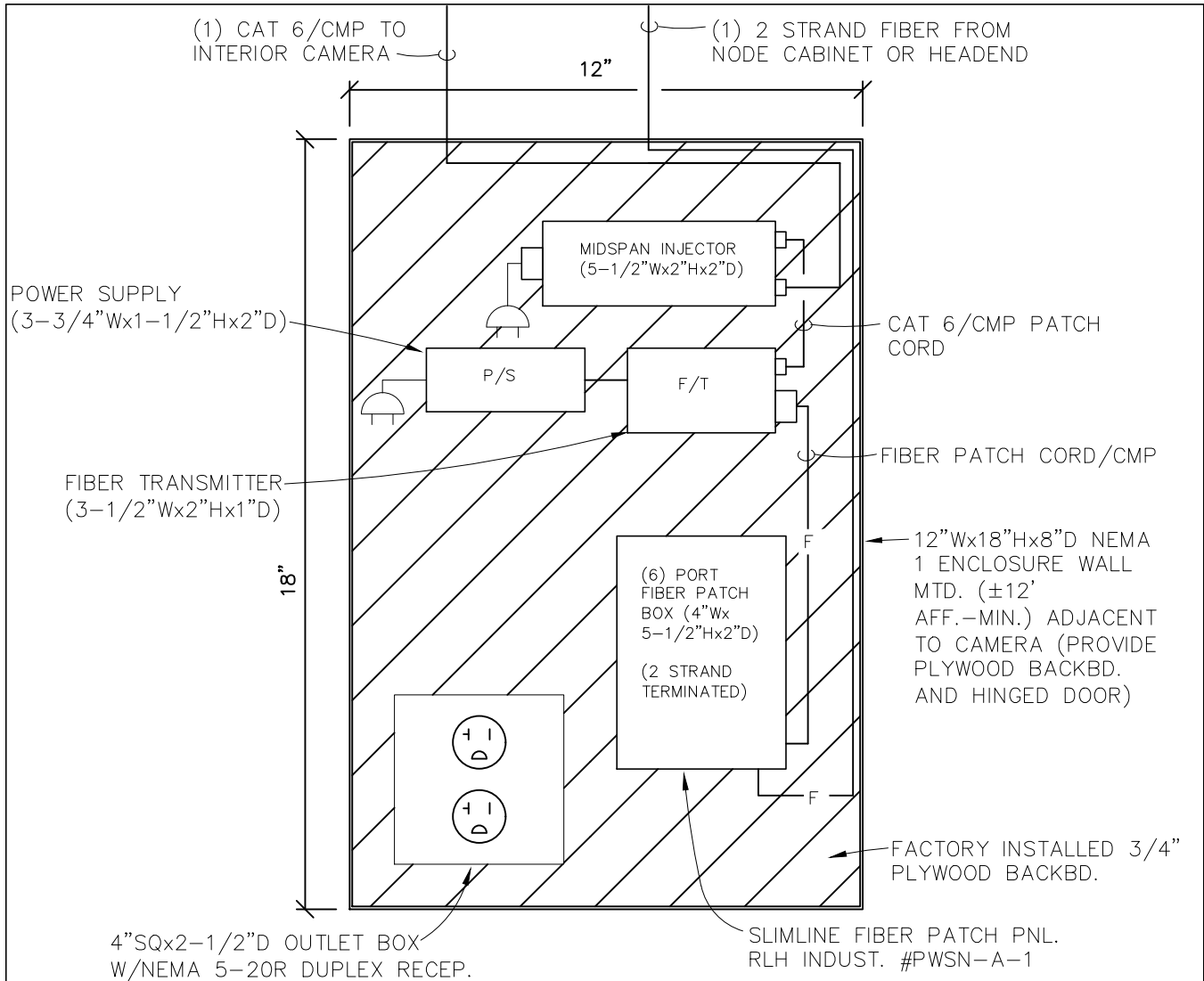

NOTES:

1. ALL COMPONENTS SHALL BE SECURELY FASTENED TO THE BACKBOARD USING FACTORY BRACKETS & APPROPRIATE WOOD SCREWS. USE OF DOUBLE SIDED, ADHESIVE HOOK & LOOP STRAPS IS NOT ACCEPTABLE.
2. FIBER TRANSMITTERS SHALL NOT BE SECURED ATOP OF THE INJECTORS.
3. PATCH CORDS SHALL BE AS LONG AS NECESSARY FOR THE APPLICATION BUT AS SHORT AS POSSIBLE TO AVOID LARGE CABLE BUNDLES.
4. EXCESS CABLE LENGTHS SHALL BE PROPERLY LOOPED AND SECURED USING HOOK & LOOP STRAPS; TIE-WRAPPS ARE NOT ACCEPTABLE.
5. THE 120 VOLT WIRING ROUTED W/I THE ENCLOSURE SHALL BE CONTAINED IN CONDUIT. OPEN 120 VOLT WIRING IS NOT ACCEPTABLE.
6. A 20 FT. FIBER OPTIC SERVICE LOOP SHALL BE INSTALLED OUTSIDE THE ENCLOSURE. SERVICE LOOP SHALL BE INSTALLED SUCH THAT THE MINIMUM BEND RADIUS IS NOT EXCEEDED. ONCE THE FIBER REACHES THE PATCH PANEL THERE SHALL BE NO LESS THAN 3 FEET OF UNSHEATHED FIBER INSTALLED NEATLY IN STORAGE TRAY PRIOR TO INSTALLATION OF FAN-OUT KIT AND TERMINATIONS.

Detail: **NEMA 1 INTERIOR ENCLOSURE - SINGLE CAMERA**

Fac. | Ch. | Sect. | Para. | Detail
P5-7-0 e1

CAD File: \\12 standard details\details\P5-7-0e1.dwg

Scale: **3" = 1'-0"**

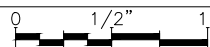

Last Revised: 10/1/2023

NOTES TO A/E:

- RECEPTACLES MOUNTED WITHIN THE NEMA 4 SHALL NOT BE "GFCI" TYPE.

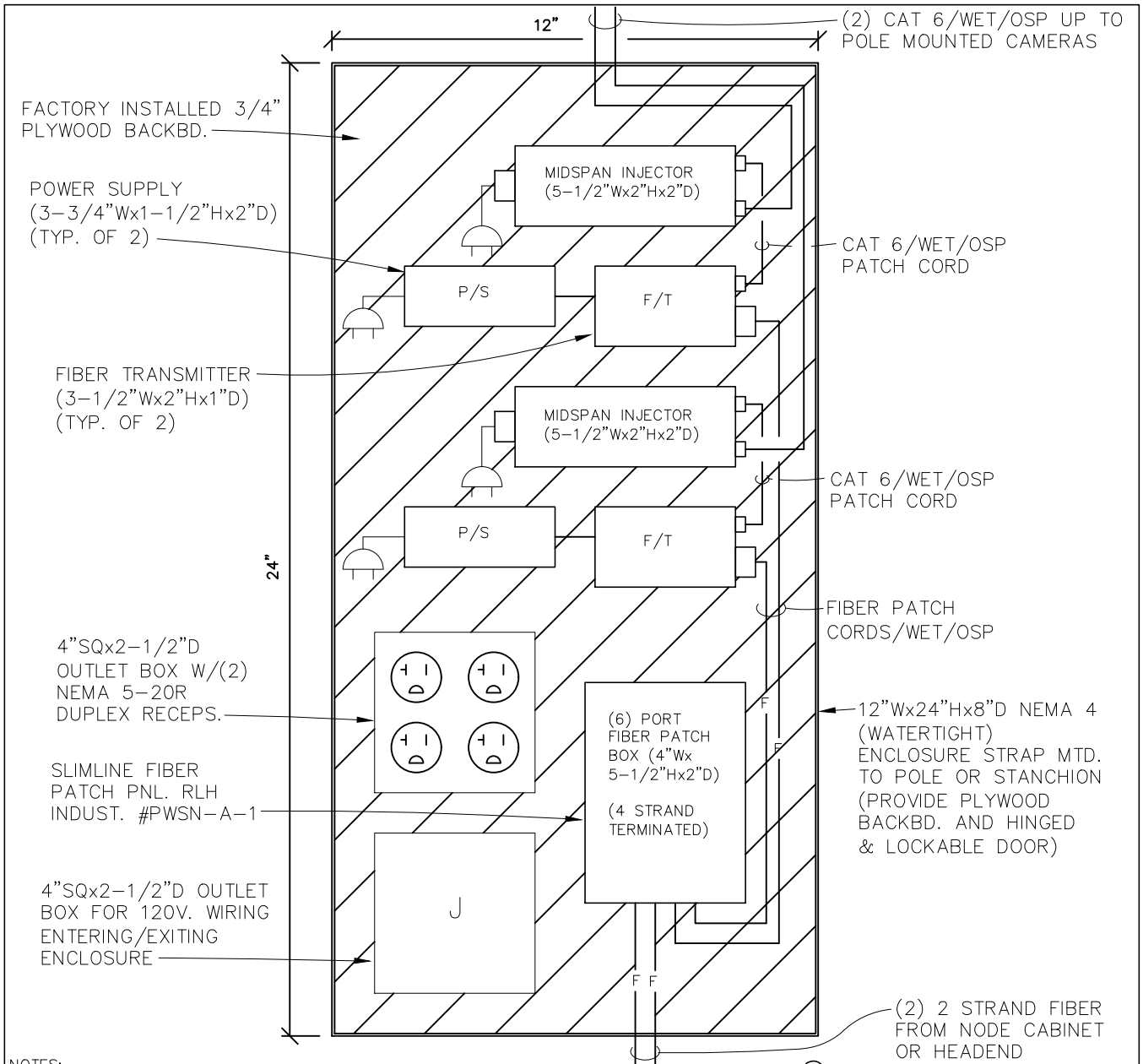

NOTES:

- ENCLOSURE SHALL BE NEMA 4 RATED STAINLESS STEEL OR NONMETALLIC, POLYCARBONATE TYPE.
- ALL COMPONENTS SHALL BE SECURELY FASTENED TO THE BACKBOARD USING FACTORY BRACKETS & APPROPRIATE WOOD SCREWS. USE OF DOUBLE SIDED, ADHESIVE HOOK & LOOP STRAPS IS NOT ACCEPTABLE.
- FIBER TRANSMITTERS SHALL NOT BE SECURED ATOP OF THE INJECTORS.
- PATCH CORDS SHALL BE AS LONG AS NECESSARY FOR THE APPLICATION BUT AS SHORT AS POSSIBLE TO AVOID LARGE CABLE BUNDLES.
- EXCESS CABLE LENGTHS SHALL BE PROPERLY LOOPED AND SECURED USING HOOK & LOOP STRAPS; TIE-WRAPPS ARE NOT ACCEPTABLE.
- THE 120 VOLT WIRING ROUTED W/I THE ENCLOSURE SHALL BE CONTAINED IN CONDUIT. OPEN 120 VOLT WIRING IS NOT ACCEPTABLE. PROVIDE 120 VOLT SPD'S (EDCO #FAS-100F) @ EA. RECEP..
- A 6 FT. FIBER OPTIC SERVICE LOOP SHALL BE INSTALLED WITHIN THE ENCLOSURE. SERVICE LOOP SHALL BE INSTALLED SUCH THAT THE MINIMUM BEND RADIUS IS NOT EXCEEDED. ONCE THE FIBER REACHES THE PATCH PANEL THERE SHALL BE NO LESS THAN 3 FEET OF UNSHEATHED FIBER INSTALLED NEATLY IN STORAGE TRAY PRIOR TO INSTALLATION OF FAN-OUT KIT AND TERMINATIONS.

Detail: NEMA 4 EXTERIOR ENCLOSURE - DUAL CAMERA POLE		Fac.	Ch.	Sect.	Para.	Detail
CAD File: \12 standard details\details\P5-7-0f.dwg		Scale: 3" = 1'-0"				P5-7-0 f
					Last Revised:	10/1/2023

NOTES TO A/E:

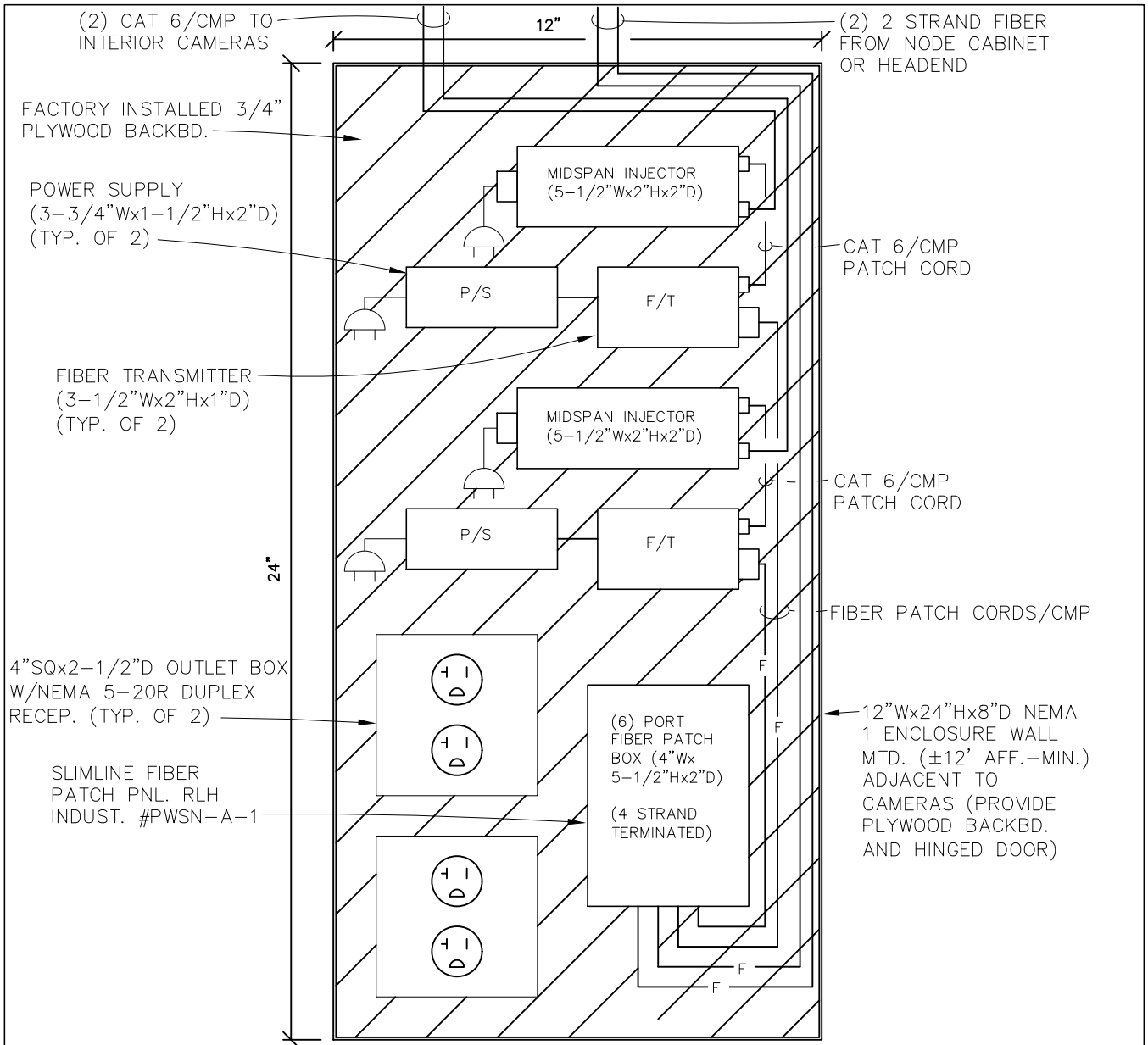

NOTES:

1. ALL COMPONENTS SHALL BE SECURELY FASTENED TO THE BACKBOARD USING FACTORY BRACKETS & APPROPRIATE WOOD SCREWS. USE OF DOUBLE SIDED, ADHESIVE HOOK & LOOP STRAPS IS NOT ACCEPTABLE.
2. FIBER TRANSMITTERS SHALL NOT BE SECURED ATOP OF THE INJECTORS.
3. PATCH CORDS SHALL BE AS LONG AS NECESSARY FOR THE APPLICATION BUT AS SHORT AS POSSIBLE TO AVOID LARGE CABLE BUNDLES.
4. EXCESS CABLE LENGTHS SHALL BE PROPERLY LOOPED AND SECURED USING HOOK & LOOP STRAPS; TIE-WRAPS ARE NOT ACCEPTABLE.
5. THE 120 VOLT WIRING ROUTED W/I THE ENCLOSURE SHALL BE CONTAINED IN CONDUIT. OPEN 120 VOLT WIRING IS NOT ACCEPTABLE.
6. A 20 FT. FIBER OPTIC SERVICE LOOP SHALL BE INSTALLED OUTSIDE THE ENCLOSURE. SERVICE LOOP SHALL BE INSTALLED SUCH THAT THE MINIMUM BEND RADIUS IS NOT EXCEEDED. ONCE THE FIBER REACHES THE PATCH PANEL THERE SHALL BE NO LESS THAN 3 FEET OF UNSHEATHED FIBER INSTALLED NEATLY IN STORAGE TRAY PRIOR TO INSTALLATION OF FAN-OUT KIT AND TERMINATIONS.

Detail: NEMA 1 INTERIOR ENCLOSURE - DUAL CAMERA	Fac. Ch. Sect. Para. Detail P5-7-0 fl
	CAD File: \12 standard details\details\P5-7-0fl.dwg
Scale: 3" = 1'-0"	
Last Revised:	10/1/2023

NOTES TO A/E:

1. PATCH PANELS WITHIN THE HEADEND & NODE CABINETS SHALL BE EQUIPPED WITH RJ45 COUPLER JACKS.
2. THIS RISER DIAGRAM IS INTENDED TO BE USED AS A GUIDE TO THE PROJECT ENGR.. THE RISER DIAGRAM SHALL BE MODIFIED TO SUITE SPECIFIC PROJECT REQUIREMENTS; QUANTITIES AND LOC'N. OF CAMERAS, NODE CABINETS & MONITORS ARE PROJECT SPECIFIC.

CCTV SYSTEM DIAGRAM LARGE POST OFFICE (TYPICAL)

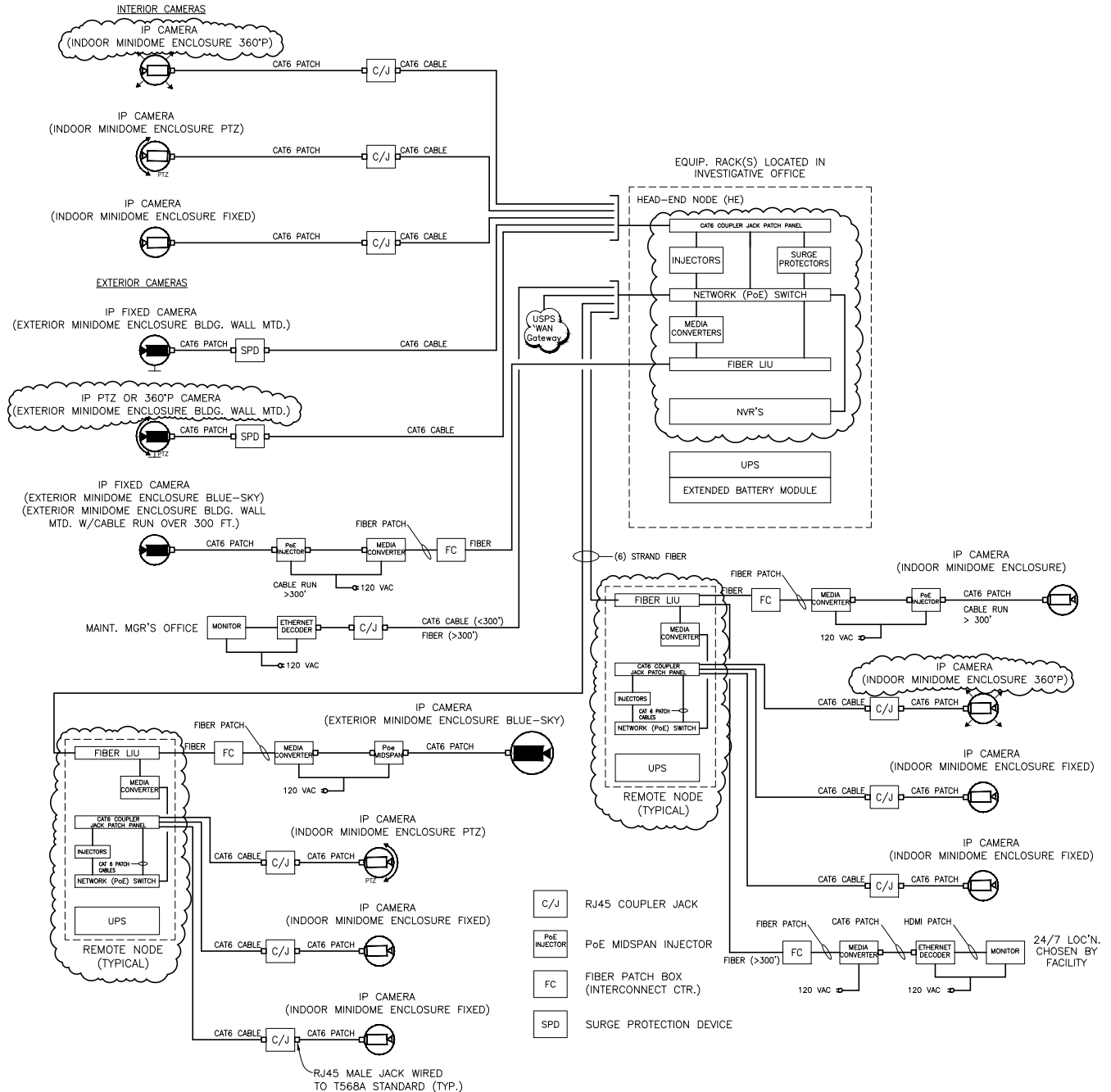

Detail:	CCTV SYSTEM - SYSTEM DIAGRAM LARGE POST OFFICE (TYPICAL)				Fac.	Ch.	Sect.	Para.	Detail	
					P5-7-0 h					
CAD File:	\usps\library\details\P5-7-0h.dwg			Scale:	NTS		0 1/2" 1"		Last Revised:	10/1/2023

NOTES TO A/E:

1. THERE ARE TWO OPTIONS IN PROVIDING POWER TO THE INVESTIGATIVE CCTV ANALOG CAMERAS:
 - a. PROVIDING POWER SUPPLIES IN THE CIO, AND RUNNING LOW VOLTAGE TO EACH CAMERA. PRIMARILY USED IN SMALLER FACILITIES WHERE CAMERAS ARE LOCATED WITHIN 500 FT OF THE CIO. REFER TO DETAIL P5-7-1a.
 - b. PROVIDING 120V OUTLETS AT EACH CAMERA, THEN USING A LOW VOLTAGE POWER SUPPLY TO POWER THE CAMERA. PRIMARILY USED FOR CAMERAS IN EXCESS OF 500FT FROM THE CIO. REFER TO DETAIL P5-7-1b

SELECT THE CORRECT DETAIL AND COORDINATE THE ELECTRICAL OUTLETS SHOWN ON SECURITY PLANS WITH POWER REQUIREMENTS OF ACTUAL SYSTEM USED.
2. CAMERA POWER SUPPLIES SHALL BE PROVIDED BY THE LOW VOLTAGE SUBCONTRACTOR.

NOTES:

1. ROUTE CABLES OPEN AND CONCEALED WITHIN ACCESSIBLE CEILING SPACES USING CABLE LOOP SUPPORTS @ 5 FT. SPACINGS. OPEN CABLING MAY BE ROUTED WITHIN EXPOSED WORKROOM CEILING SPACES MORE THAN 10 FT. AFF..
2. CABLING ROUTED EXTERIOR OF THE BLDG., ROUTED UNDERGROUND, ROUTED THRU INACCESSIBLE CEILING SPACES OR ROUTED EXPOSED LESS THAN 10 FT. ABOVE THE WORKROOM FLOOR MUST BE CONTAINED IN CONDUIT.

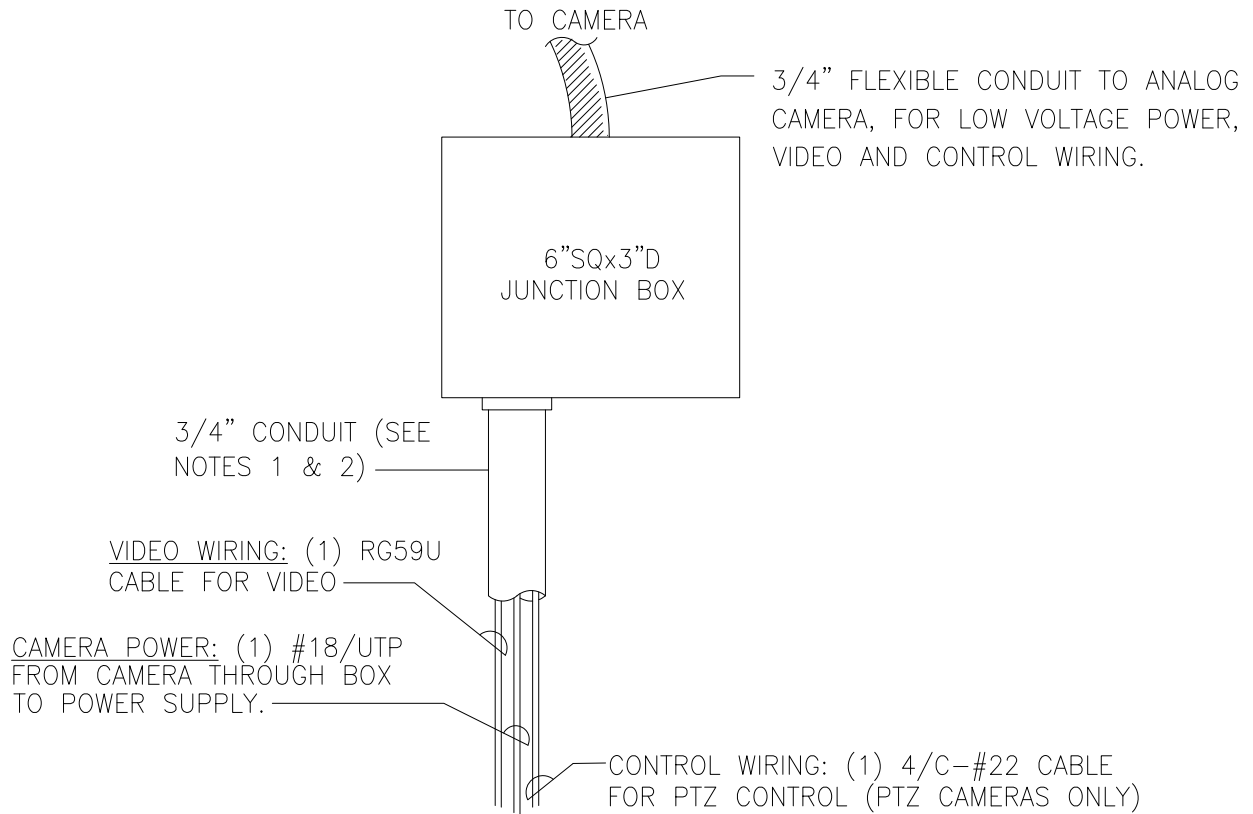

FOR TOTAL CABLE LENGTHS (FROM CAMERA TO CIO) OF 500 LINEAR FEET OR LESS, RUN ALL WIRES IN 3/4" CONDUIT TO CIO AND LOCATE POWER SUPPLIES IN CIO. IF FACILITY DOES NOT HAVE A CIO, LOCATE POWER SUPPLIES IN SECURITY POSTAL POLICE CONTROL ROOM OR MDF/LAN ROOM.

Detail:	CRIMINAL INVESTIGATIVE SYSTEM (CIS) - ANALOG CCTV JUNCTION BOX DETAIL (R & A)	Fac.	Ch.	Sect.	Para.	Detail	
						P5-7-1a	
CAD File:	\12 standard details\details\P5-7-1a.dwg	Scale:	NONE			Last Revised:	8/31/2021

NOTES TO A/E:

1. THE OVERALL HEIGHT OF THE POLE MUST BE COORDINATED WITH THE SPECIFIC CAMERA APPLICATION. POLE MOUNTED CAMERA HEIGHTS RANGE FROM 11' AFG TO 20' AFG DEPENDING ON THEIR PURPOSE.
2. POLE ASSEMBLY, ANCHOR BOLTS AND CONC. BASE SHALL BE PROPERLY SIZED FOR THE APPLICABLE WIND LOADING.
3. THE MOUNTING HARDWARE REQUIRED FOR PTZ'S, FIXED & MULTI-D/S OUTDOOR CAMERAS DIFFERS BASED ON CAMERA TYPE & MOUNTING APPLICATION. REFER TO LISTING OF APPROVED OUTDOOR CAMERA MOUNTS CONTAINED W/I THE "USPS CCTV SECURITY DESIGN REQUIREMENTS" DOCUMENTS, FOLDER "F7".

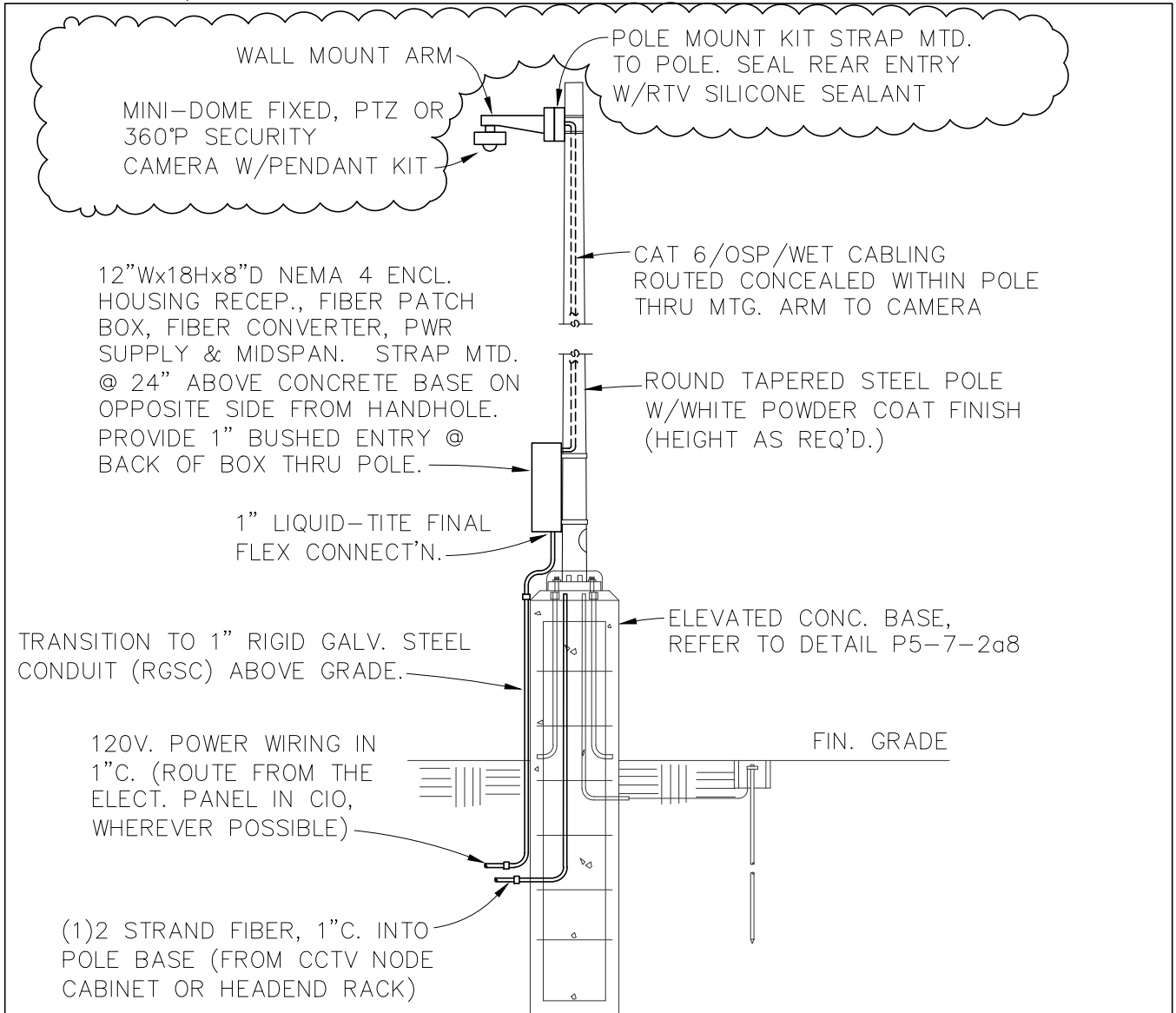

NOTES:

1. DETAIL DRAWN AS AN END-OF-LINE CAMERA. PROVIDE ADD'L. CONDUITS FOR INTERMEDIATE CAMERA LOCATIONS REQUIRING ENTERING & EXITING CONDUITS.
2. REFER TO DETAIL P5-7-0e FOR INTERIOR LAYOUT OF THE NEMA 4 ENCLOSURE.

Detail:	POLE MOUNTED CAMERA DETAIL - SINGLE CAMERA (NEW CONSTRUCTION)				Fac.	Ch.	Sect.	Para.	Detail	
					P5-7-2 a					
CAD File:	\12 standard details\details\P5-7-2a.dwg			Scale:	NONE		0 1/2" 1"		Last Revised:	10/1/2023



STANDARD DETAIL LIBRARY

NOTES TO A/E:

1. THE CAMERA MOUNTING HEIGHT MUST BE COORDINATED WITH THE SPECIFIC CAMERA APPLICATION. POLE MOUNTED CAMERA HEIGHTS RANGE FROM 11' AFG TO 20' AFG DEPENDING ON THEIR PURPOSE.
2. THE MOUNTING HARDWARE REQUIRED FOR PTZ'S, FIXED & MULTI-D/S OUTDOOR CAMERAS DIFFERS BASED ON CAMERA TYPE & MOUNTING APPLICATION. REFER TO LISTING OF APPROVED OUTDOOR CAMERA MOUNTS CONTAINED W/I THE "USPS CCTV SECURITY DESIGN REQUIREMENTS" DOCUMENTS, FOLDER "F7".

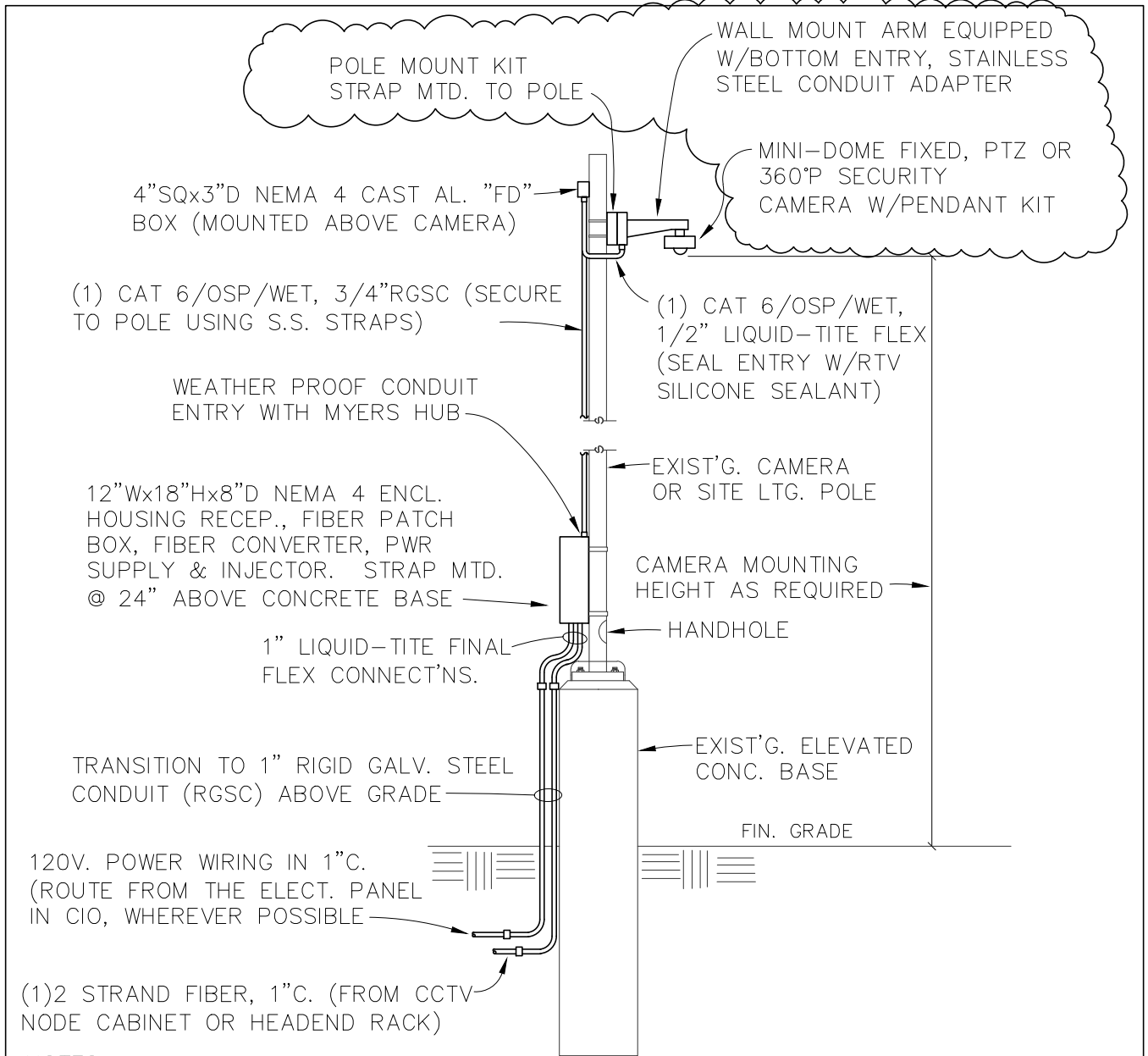

- NOTES:**
1. DETAIL DRAWN AS AN END-OF-LINE CAMERA. PROVIDE ADD'L. CONDUITS FOR INTERMEDIATE CAMERA LOCATIONS REQUIRING ENTERING & EXITING CONDUITS.
 2. REFER TO DETAIL P5-7-0e FOR INTERIOR LAYOUT OF THE NEMA 4 ENCLOSURE.

Detail: POLE MOUNTED CAMERA DETAIL - SINGLE CAMERA (EXISTING CONSTRUCTION)		Fac.	Ch.	Sect.	Para.	Detail
CAD File: \12 standard details\details\P5-7-2a1.dwg		Scale: NONE				P5-7-2 a1
Last Revised: 10/1/2023						

© Copyright 1997-2015 United States Postal Service



STANDARD DETAIL LIBRARY

NOTES TO A/E:

1. THE OVERALL HEIGHT OF THE POLE MUST BE COORDINATED WITH THE SPECIFIC CAMERA APPLICATION. POLE MOUNTED CAMERA HEIGHTS RANGE FROM 11' AFG TO 20' AFG DEPENDING ON THEIR PURPOSE.
2. POLE ASSEMBLY, ANCHOR BOLTS AND CONC. BASE SHALL BE PROPERLY SIZED FOR THE APPLICABLE WIND LOADING.
3. THE MOUNTING HARDWARE REQUIRED FOR PTZ'S, FIXED & MULTI-D/S OUTDOOR CAMERAS DIFFERS BASED ON CAMERA TYPE & MOUNTING APPLICATION. REFER TO LISTING OF APPROVED OUTDOOR CAMERA MOUNTS CONTAINED W/I THE "USPS CCTV SECURITY DESIGN REQUIREMENTS" DOCUMENTS, FOLDER "F7".

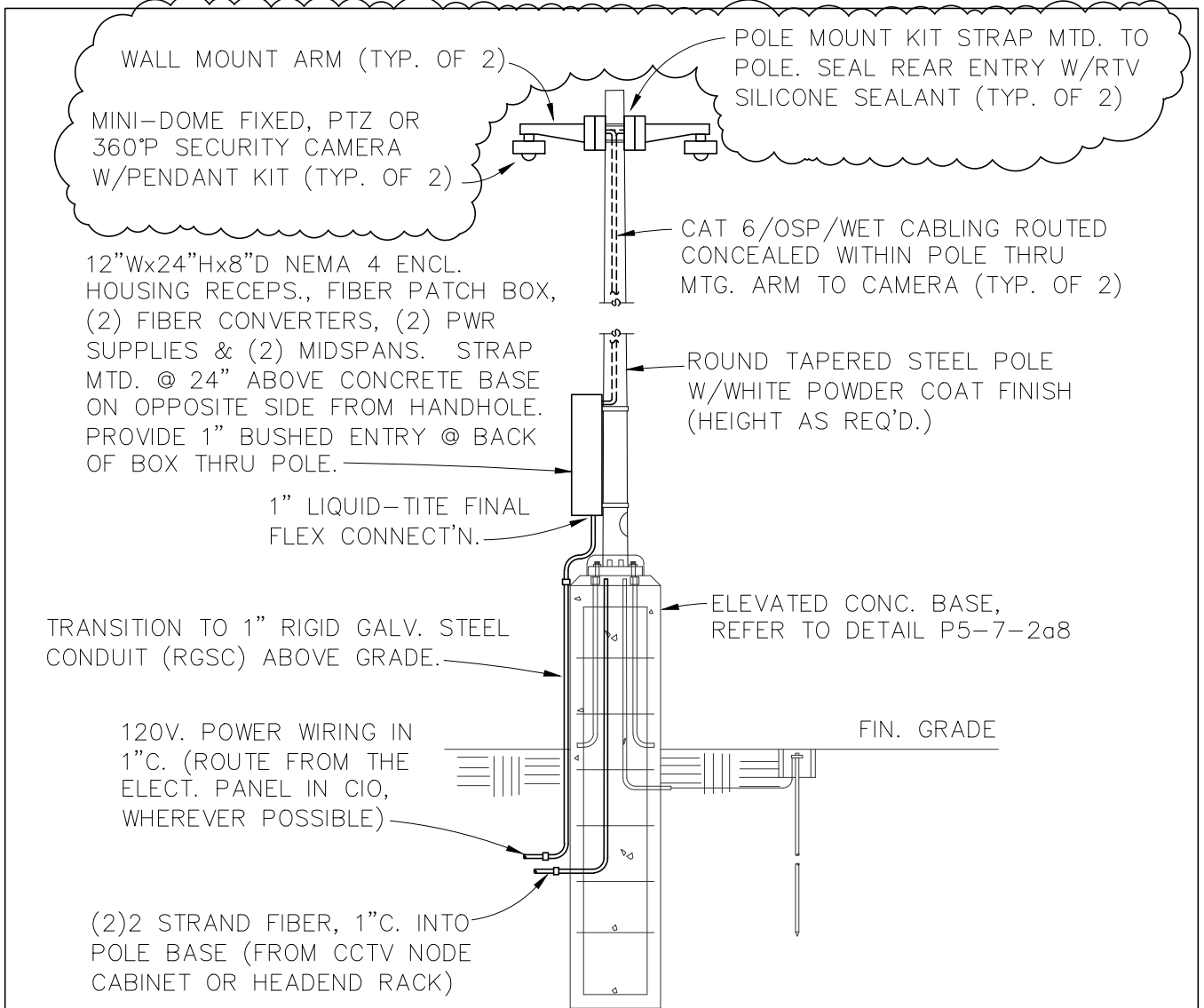

NOTES:

1. DETAIL DRAWN AS AN END-OF-LINE CAMERA. PROVIDE ADD'L. CONDUITS FOR INTERMEDIATE CAMERA LOCATIONS REQUIRING ENTERING & EXITING CONDUITS.
2. REFER TO DETAIL P5-7-0f FOR INTERIOR LAYOUT OF THE NEMA 4 ENCLOSURE.

Detail: POLE MOUNTED CAMERA DETAIL - DUAL CAMERAS (NEW CONSTRUCTION)	Fac. Ch. Sect. Para. Detail P5-7-2 a2
	CAD File: \12 standard details\details\P5-7-2a2.dwg Scale: NONE 0 1/2" 1" Last Revised: 10/1/2023



STANDARD DETAIL LIBRARY

NOTES TO A/E:

1. THE CAMERA MOUNTING HEIGHT MUST BE COORDINATED WITH THE SPECIFIC CAMERA APPLICATION. POLE MOUNTED CAMERA HEIGHTS RANGE FROM 11' AFG TO 20' AFG DEPENDING ON THEIR PURPOSE.
2. THE MOUNTING HARDWARE REQUIRED FOR PTZ'S, FIXED & MULTI-D/S OUTDOOR CAMERAS DIFFERS BASED ON CAMERA TYPE & MOUNTING APPLICATION. REFER TO LISTING OF APPROVED OUTDOOR CAMERA MOUNTS CONTAINED W/I THE "USPS CCTV SECURITY DESIGN REQUIREMENTS" DOCUMENTS, FOLDER "F7".

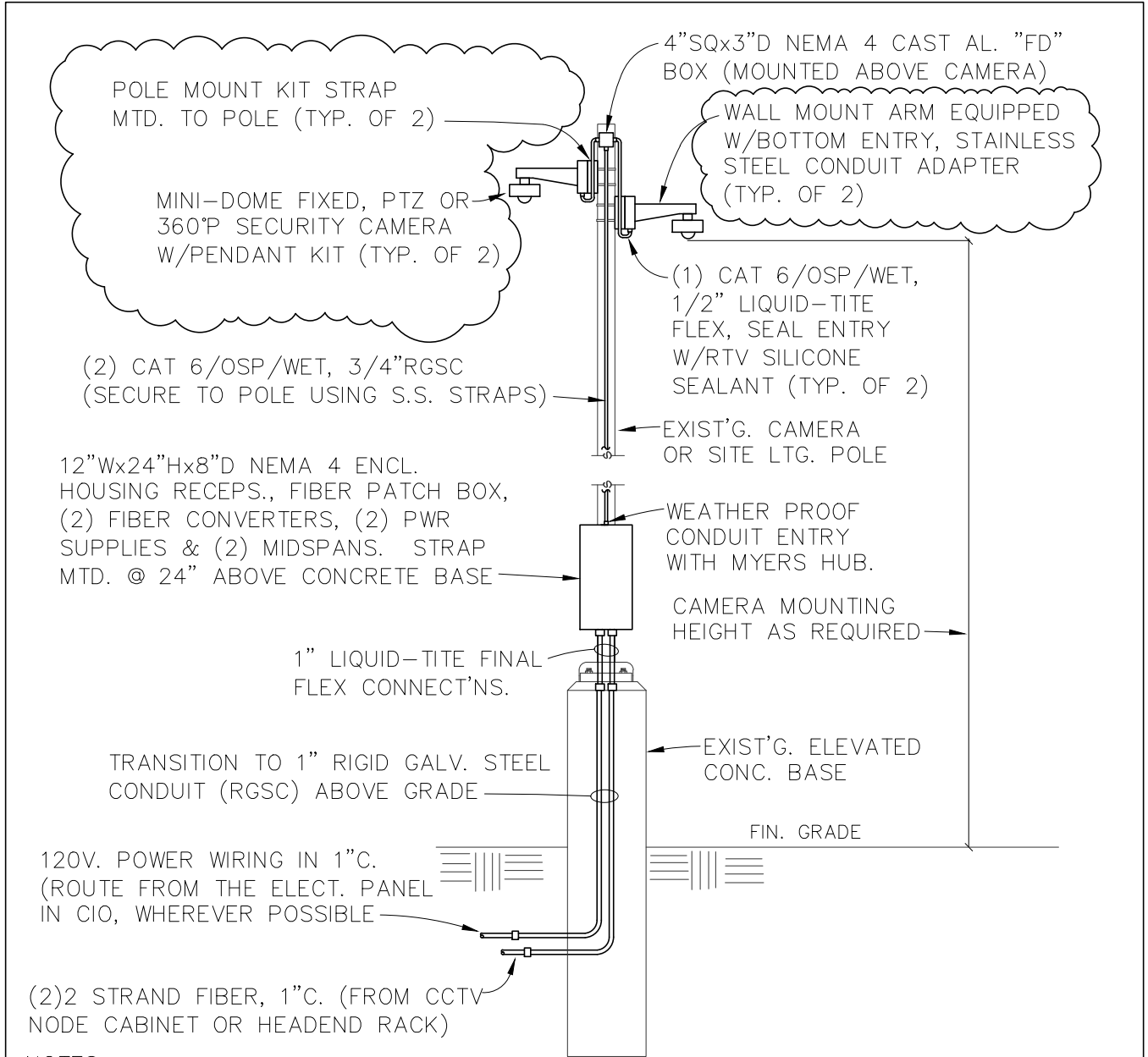

NOTES:

1. DETAIL DRAWN AS AN END-OF-LINE CAMERA. PROVIDE ADD'L. CONDUITS FOR INTERMEDIATE CAMERA LOCATIONS REQUIRING ENTERING & EXITING CONDUITS.
2. REFER TO DETAIL P5-7-0f FOR INTERIOR LAYOUT OF THE NEMA 4 ENCLOSURE.

Detail: POLE MOUNTED CAMERA DETAIL - DUAL CAMERAS (EXISTING CONSTRUCTION)	Fac. Ch. Sect. Para. Detail P5-7-2 a3
	CAD File: \12 standard details\details\P5-7-2a3.dwg Scale: NONE 0 1/2" 1" Last Revised: 10/1/2023

NOTES TO A/E:

1. THE OVERALL HEIGHT OF THE POLE MUST BE COORDINATED WITH THE SPECIFIC CAMERA APPLICATION. POLE MOUNTED CAMERA HEIGHTS RANGE FROM 11' AFG TO 20' AFG DEPENDING ON THEIR PURPOSE.
2. POLE ASSEMBLY, ANCHOR BOLTS AND CONC. BASE SHALL BE PROPERLY SIZED FOR THE APPLICABLE WIND LOADING.
3. THE MOUNTING HARDWARE REQUIRED FOR PTZ'S, FIXED & MULTI-D/S OUTDOOR CAMERAS DIFFERS BASED ON CAMERA TYPE & MOUNTING APPLICATION. REFER TO LISTING OF APPROVED OUTDOOR CAMERA MOUNTS CONTAINED W/I THE "USPS CCTV SECURITY DESIGN REQUIREMENTS" DOCUMENTS, FOLDER "F7".

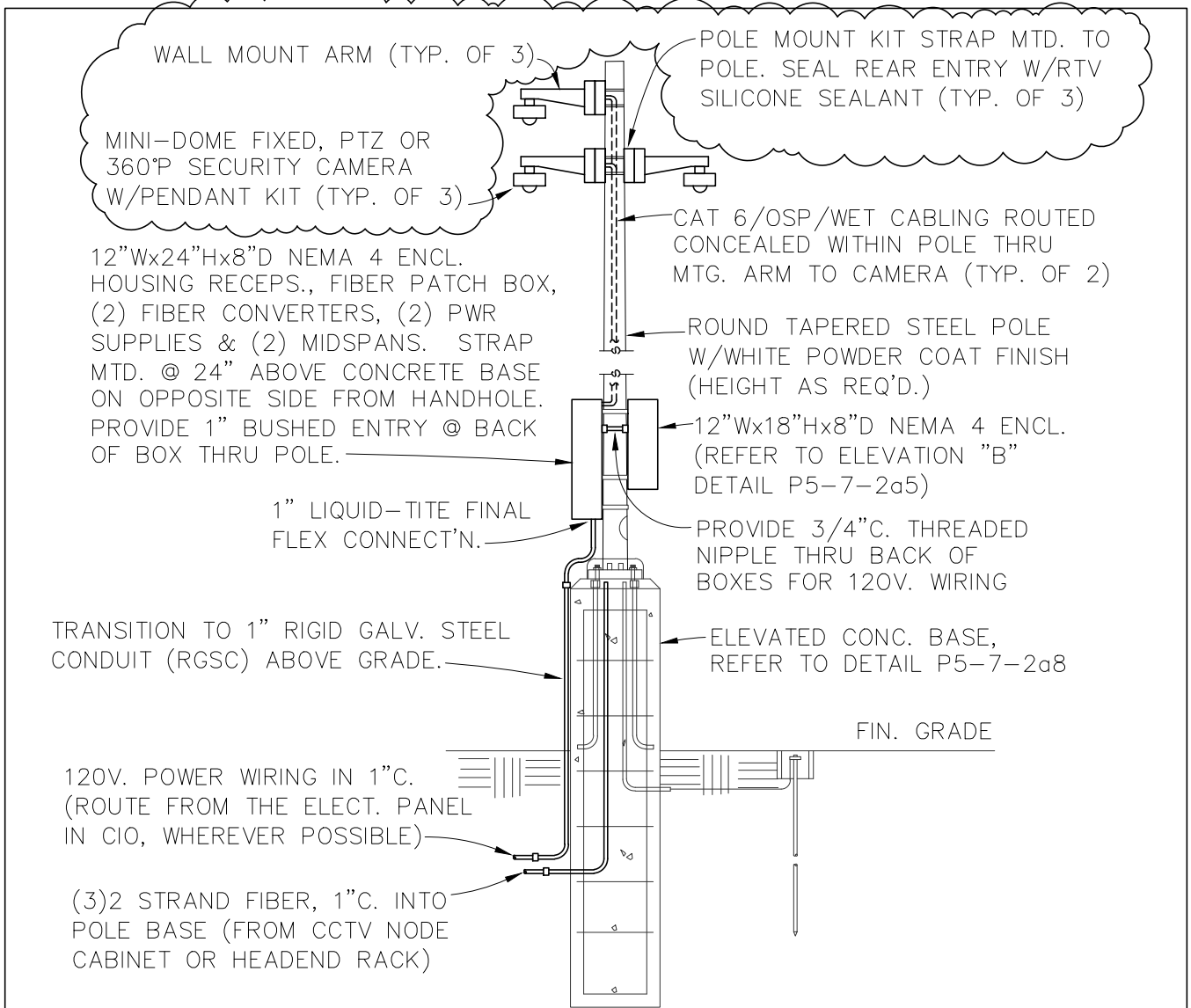

ELEVATION "A"

NOTES:

1. DETAIL DRAWN AS AN END-OF-LINE CAMERA. PROVIDE ADD'L. CONDUITS FOR INTERMEDIATE CAMERA LOCATIONS REQUIRING ENTERING & EXITING CONDUITS.
2. REFER TO DETAIL P5-7-0f FOR INTERIOR LAYOUT OF THE NEMA 4 ENCLOSURE.

Detail: POLE MOUNTED CAMERA DETAIL - TRIPLE CAMERAS (NEW CONSTRUCTION)	Fac. Ch. Sect. Para. Detail P5-7-2 a4
	CAD File: \12 standard details\details\P5-7-2a4.dwg Scale: NONE 0 1/2" 1" Last Revised: 10/1/2023

© Copyright 1997-2015 United States Postal Service



STANDARD DETAIL LIBRARY

NOTES TO A/E:

1. THE OVERALL HEIGHT OF THE POLE MUST BE COORDINATED WITH THE SPECIFIC CAMERA APPLICATION. POLE MOUNTED CAMERA HEIGHTS RANGE FROM 11' AFG TO 20' AFG DEPENDING ON THEIR PURPOSE.
2. POLE ASSEMBLY, ANCHOR BOLTS AND CONC. BASE SHALL BE PROPERLY SIZED FOR THE APPLICABLE WIND LOADING.
3. THE MOUNTING HARDWARE REQUIRED FOR PTZ'S, FIXED & MULTI-D/S OUTDOOR CAMERAS DIFFERS BASED ON CAMERA TYPE & MOUNTING APPLICATION. REFER TO LISTING OF APPROVED OUTDOOR CAMERA MOUNTS CONTAINED W/I THE "USPS CCTV SECURITY DESIGN REQUIREMENTS" DOCUMENTS, FOLDER "F7".

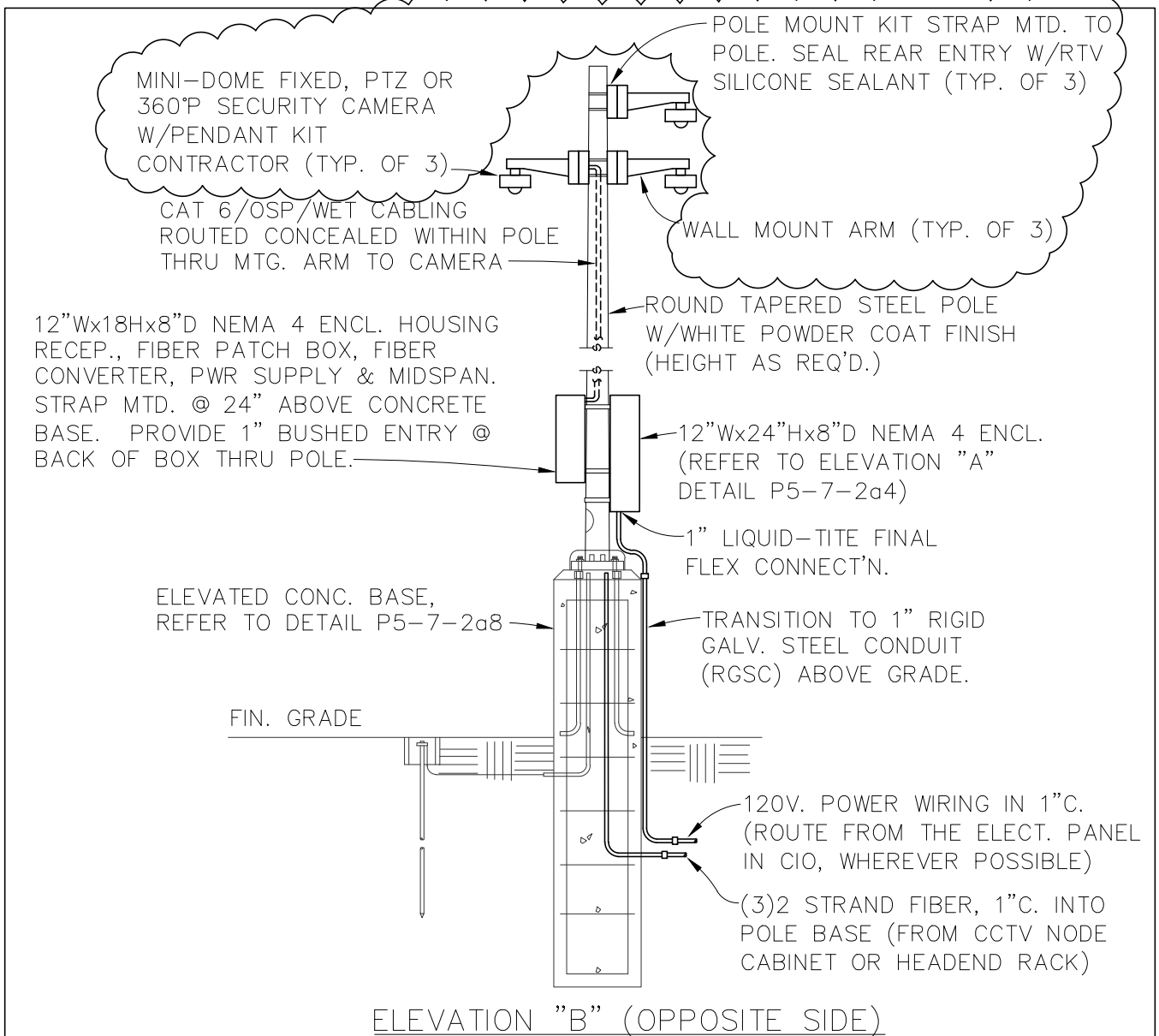

NOTES:

1. DETAIL DRAWN AS AN END-OF-LINE CAMERA. PROVIDE ADD'L. CONDUITS FOR INTERMEDIATE CAMERA LOCATIONS REQUIRING ENTERING & EXITING CONDUITS.
2. REFER TO DETAIL P5-7-0e FOR INTERIOR LAYOUT OF THE NEMA 4SS ENCLOSURE.

Detail:	POLE MOUNTED CAMERA DETAIL - TRIPLE CAMERAS (NEW CONSTRUCTION)				Fac.	Ch.	Sect.	Para.	Detail
					P5-7-2 a5				
CAD File:	Scale:			0 1/2" 1"		Last Revised: 10/1/2023			
\12 standard details\details\P5-7-2a5.dwg				NONE					



STANDARD DETAIL LIBRARY

NOTES TO A/E:

1. THE CAMERA MOUNTING HEIGHT MUST BE COORDINATED WITH THE SPECIFIC CAMERA APPLICATION. POLE MOUNTED CAMERA HEIGHTS RANGE FROM 11' AFG TO 20' AFG DEPENDING ON THEIR PURPOSE.
2. THE MOUNTING HARDWARE REQUIRED FOR PTZ'S, FIXED & MULTI-D/S OUTDOOR CAMERAS DIFFERS BASED ON CAMERA TYPE & MOUNTING APPLICATION. REFER TO LISTING OF APPROVED OUTDOOR CAMERA MOUNTS CONTAINED W/I THE "USPS CCTV SECURITY DESIGN REQUIREMENTS" DOCUMENTS, FOLDER "F7".

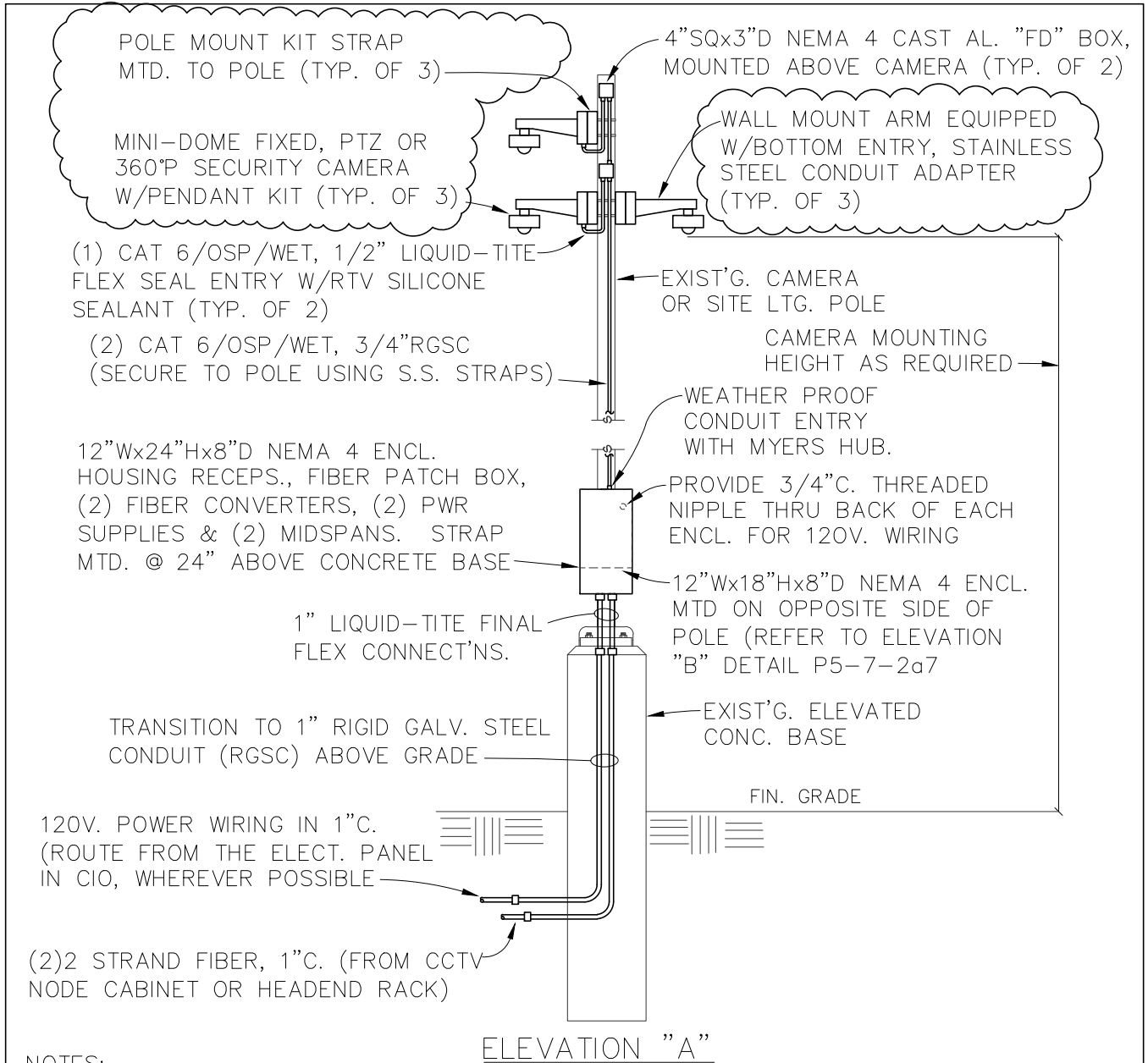

NOTES:

1. DETAIL DRAWN AS AN END-OF-LINE CAMERA. PROVIDE ADD'L. CONDUITS FOR INTERMEDIATE CAMERA LOCATIONS REQUIRING ENTERING & EXITING CONDUITS.
2. REFER TO DETAIL P5-7-0f FOR INTERIOR LAYOUT OF THE NEMA 4 ENCLOSURE.

Detail: POLE MOUNTED CAMERA DETAIL - TRIPLE CAMERAS (EXISTING CONSTRUCTION)	Fac. Ch. Sect. Para. Detail P5-7-2 a6
	CAD File: \12 standard details\details\P5-7-2a6.dwg Scale: NONE 0 1/2" 1" Last Revised: 10/1/2023



STANDARD DETAIL LIBRARY

NOTES TO A/E:

1. THE CAMERA MOUNTING HEIGHT MUST BE COORDINATED WITH THE SPECIFIC CAMERA APPLICATION. POLE MOUNTED CAMERA HEIGHTS RANGE FROM 11' AFG TO 20' AFG DEPENDING ON THEIR PURPOSE.
2. THE MOUNTING HARDWARE REQUIRED FOR PTZ'S, FIXED & MULTI-D/S OUTDOOR CAMERAS DIFFERS BASED ON CAMERA TYPE & MOUNTING APPLICATION. REFER TO LISTING OF APPROVED OUTDOOR CAMERA MOUNTS CONTAINED W/I THE "USPS CCTV SECURITY DESIGN REQUIREMENTS" DOCUMENTS, FOLDER "F7".

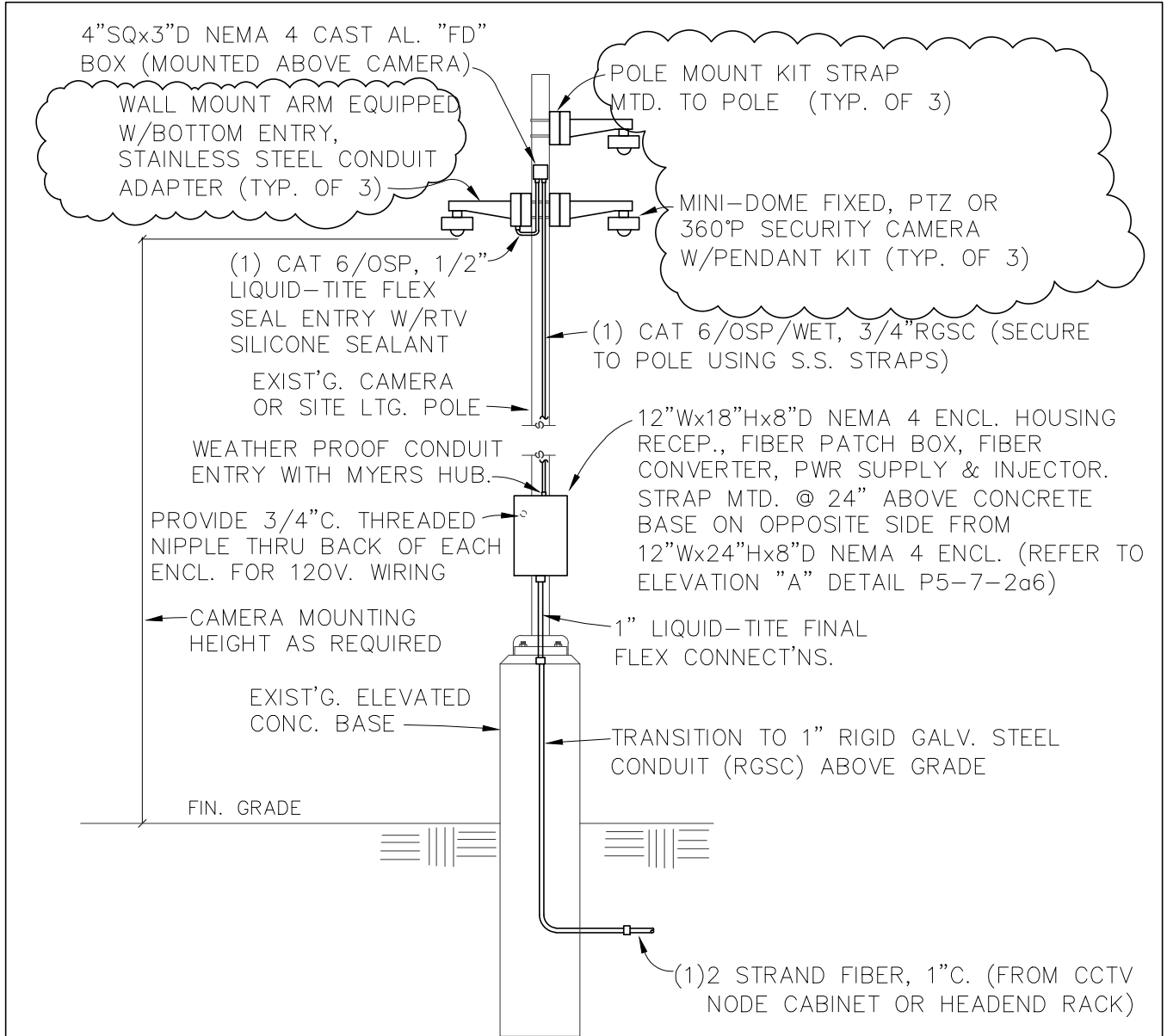

ELEVATION "B" (OPPOSITE SIDE)

NOTES:

1. DETAIL DRAWN AS AN END-OF-LINE CAMERA. PROVIDE ADD'L. CONDUITS FOR INTERMEDIATE CAMERA LOCATIONS REQUIRING ENTERING & EXITING CONDUITS.
2. REFER TO DETAIL P5-7-0e FOR INTERIOR LAYOUT OF THE NEMA 4 ENCLOSURE.

Detail:	POLE MOUNTED CAMERA DETAIL - TRIPLE CAMERAS (EXISTING CONSTRUCTION)				Fac.	Ch.	Sect.	Para.	Detail	
					P5-7-2 a7					
CAD File:	\12 standard details\details\P5-7-2a7.dwg			Scale:	NONE		0 1/2" 1"		Last Revised:	10/1/2023



STANDARD DETAIL LIBRARY

NOTES TO A/E:

1. POLE ASSEMBLY, ANCHOR BOLTS AND CONC. BASE SHALL BE PROPERLY SIZED FOR THE APPLICABLE WIND LOADING.
2. POLES TO BE MOUNTED IN COASTAL OR SUBTROPICAL CLIMATES SHALL BE PROVIDED WITH STAINLESS STEEL ANCHOR BOLTS & HARDWARE.
3. REFER TO DETAILS P5-7-2a, P5-7-2a2 & P5-7-2a4 FOR SPECIFIC POLE & CAMERA MOUNTING DETAILS.

CONCRETE POLE BASE REQUIREMENTS		
POLE LOCATION	BASE HEIGHT	BASE DIAM.
MORE THAN 10'-0" BEHIND THE FACE OF A CURB AT TRUCK PARKING AREA	4'-0"	24"
WITHIN 10'-0" BEHIND THE FACE OF A CURB AT TRUCK PARKING AREAS AND DRIVES	4'-0"	30"
IN THE MIDDLE OF A TRUCK PARKING AREA	5'-0"	36"
3'-0" OR LESS BEHIND THE FACE OF A CURB AT CAR PARKING AREAS AND DRIVES	3'-0"	18"
IN THE MIDDLE OF A CAR PARKING AREA	3'-0"	24"

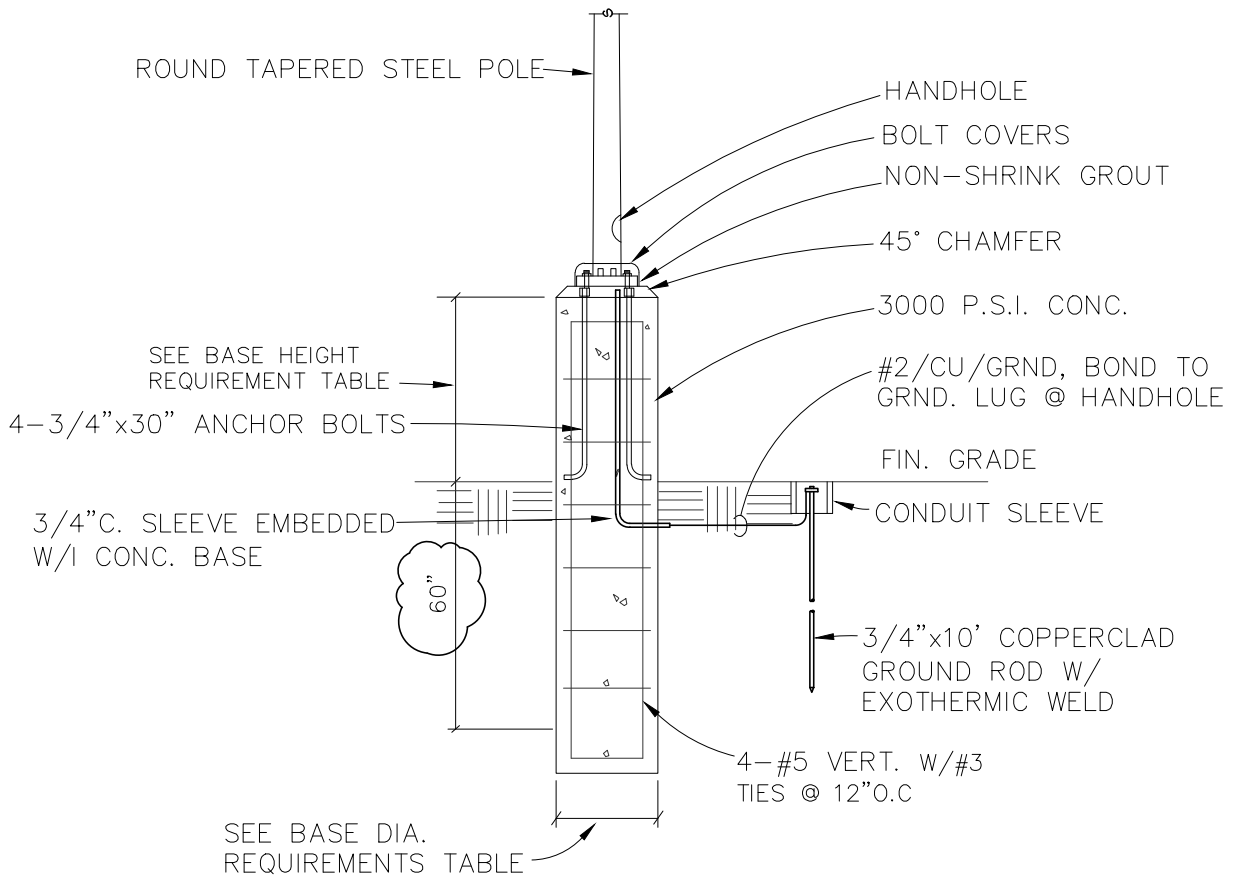

Detail: TYPICAL CONCRETE BASE DETAIL- CAMERA POLE (NEW CONSTRUCTION)	Fac. Ch. Sect. Para. Detail P5-7-2 a8
	CAD File: \12 standard details\details\P5-7-2a8.dwg Scale: NONE 0 1/2" 1" Last Revised: 10/1/2023

© Copyright 1997-2015 United States Postal Service



STANDARD DETAIL LIBRARY

NOTES TO A/E:

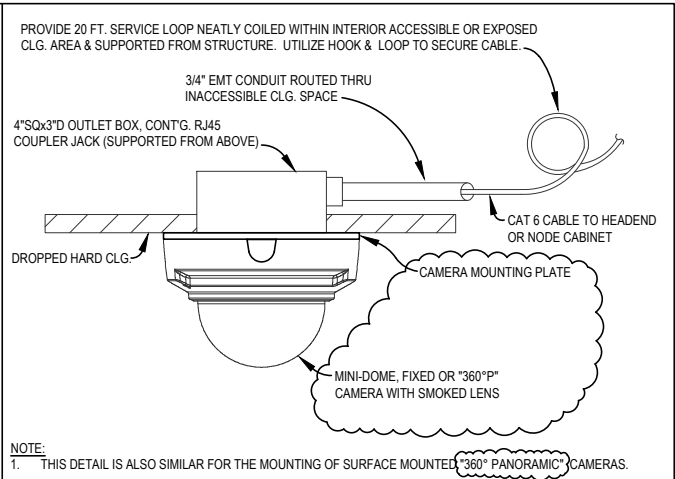
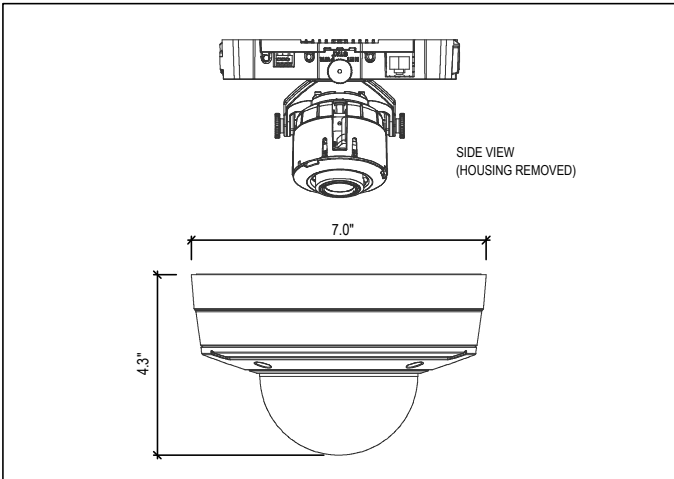

DEVICE DETAIL **A**

INTERIOR SURFACE MOUNT (DROPPED HARD CEILING) **B**

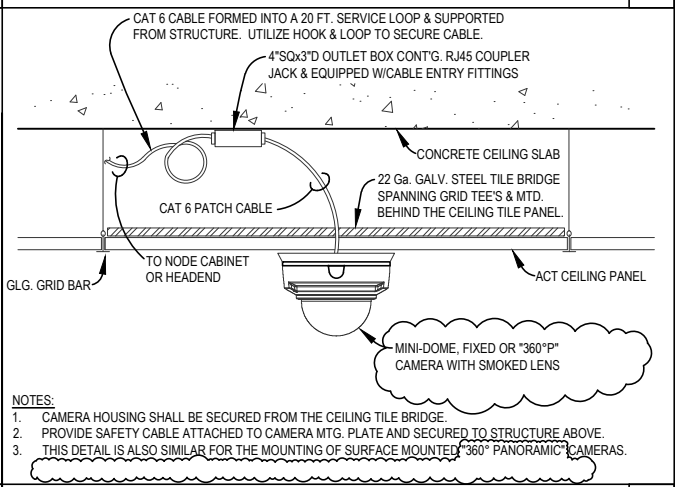
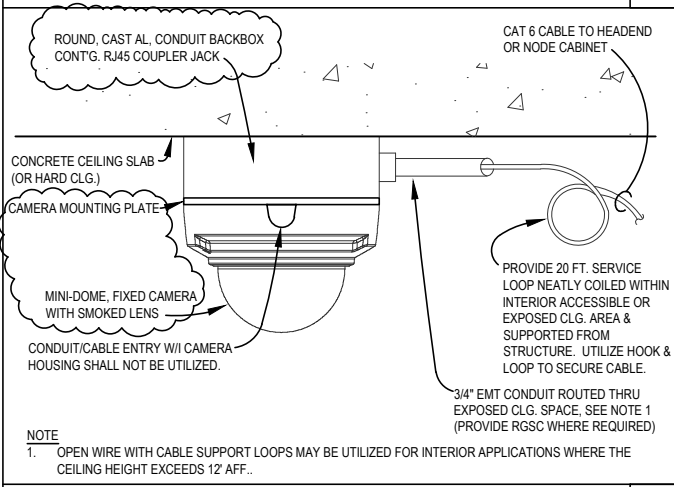

INTERIOR/EXTERIOR SURFACE CEILING MOUNT **C**

INTERIOR SURFACE MOUNT (ACT CEILING) **D**

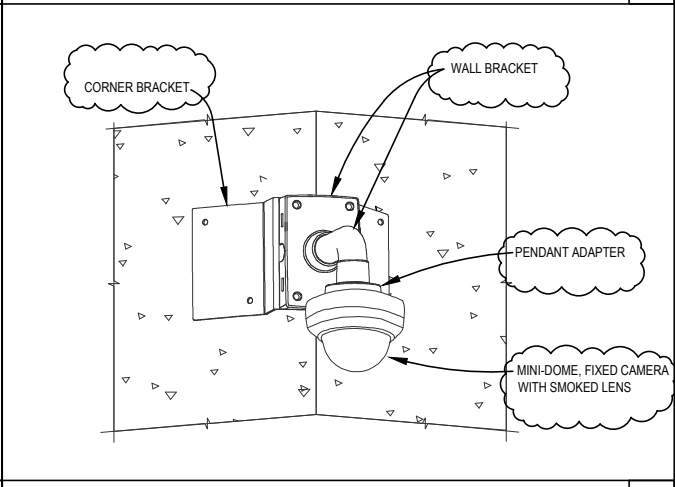
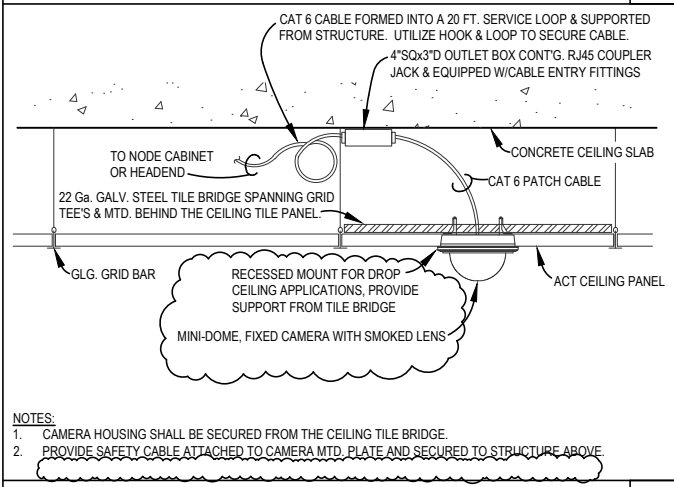

INTERIOR RECESSED MOUNT (ACT CEILING) **E**

WALL CORNER MOUNTING DETAIL **F**

Detail: FIXED CAMERA MOUNTING DETAILS					Fac. Ch. Sect. Para. Detail
P5-7-2 b					
CAD File: \\12 standard details\details\P5-7-2b.dwg		Scale: NONE			Last Revised: 10/1/2023

© Copyright 1997-2015 United States Postal Service



STANDARD DETAIL LIBRARY

NOTES TO A/E:

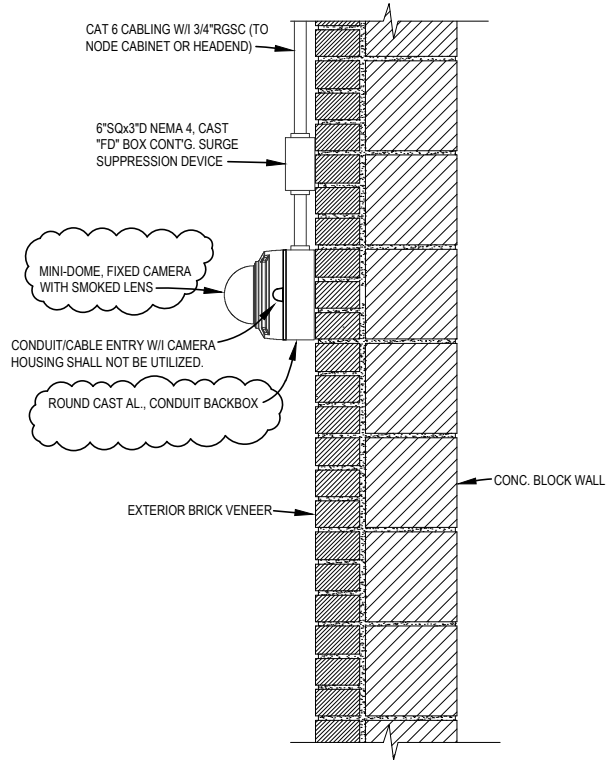
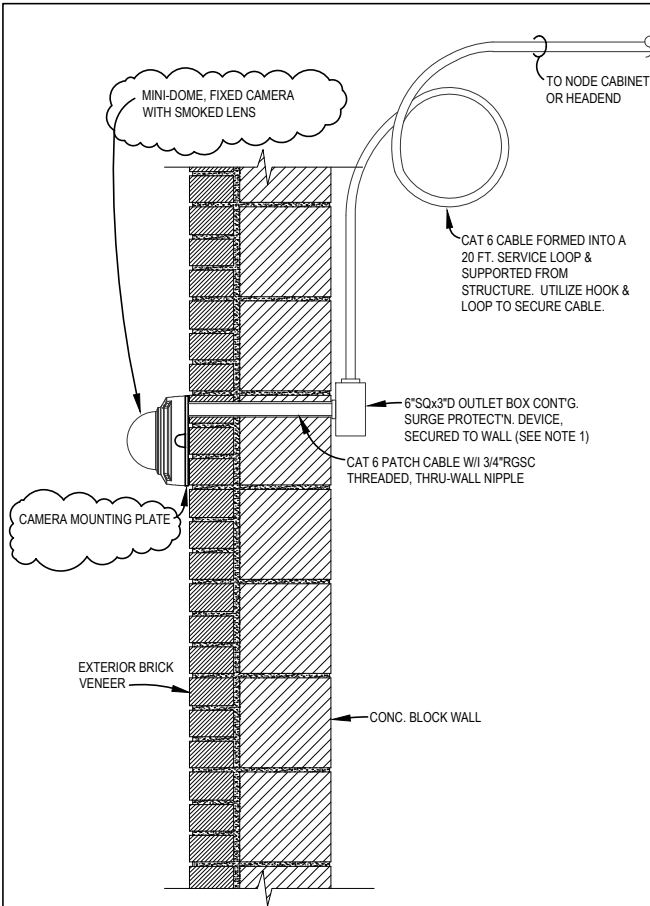

NOTE:
 1. PROVIDE CAST AL. "FD" STYLE OUTLET BOX & 3/4"RGSC FOR ALL CAT 6 CABLING ROUTED LESS THAN 10' AFF WITHIN THE WORK ROOM OR PLATFORM.

EXTERIOR SURFACE WALL MOUNT

A

EXTERIOR SURFACE WALL MOUNT

B

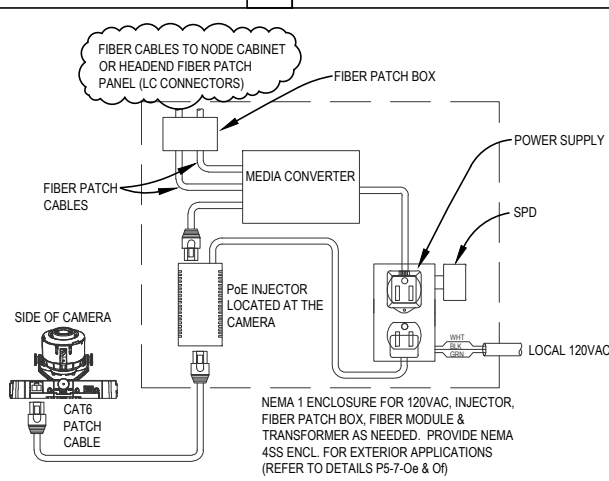
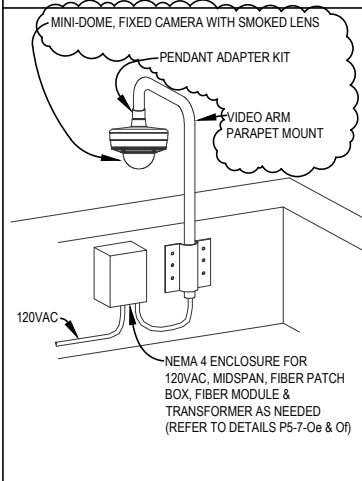

CAT6 REGULAR WIRING DETAIL

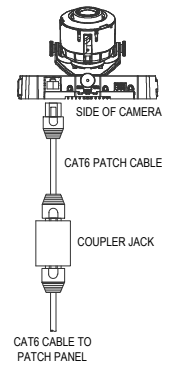

PARAPET MOUNTING DETAIL - FIBER

C

FIBER WIRING DETAIL

D

CAT6 WIRING DETAIL

E

Detail: FIXED CAMERA MOUNTING DETAILS

Fac. | Ch. | Sect. | Para. | Detail

P5-7-2 b1

CAD File: \\12 standard details\details\P5-7-2b1.dwg

Scale: NONE

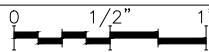

Last Revised: 10/1/2023

NOTES TO A/E:

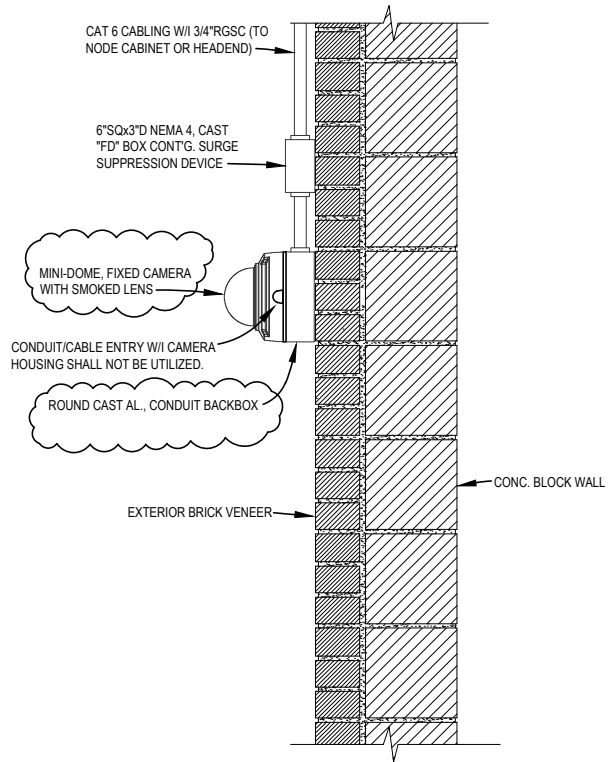
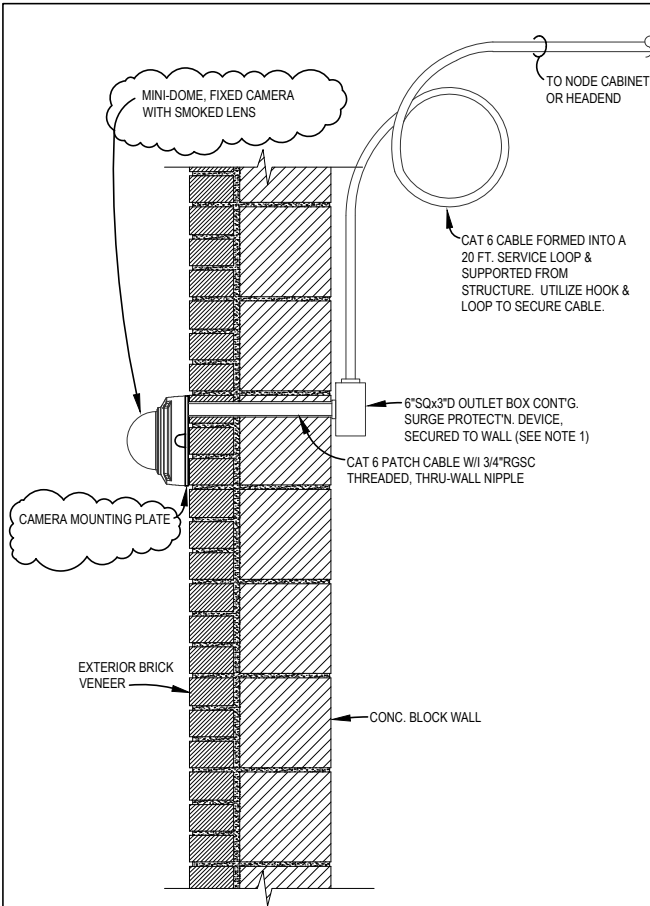

NOTE:
 1. PROVIDE CAST AL. "FD" STYLE OUTLET BOX & 3/4"RGSC FOR ALL CAT 6 CABLING ROUTED LESS THAN 10' AFF WITHIN THE WORK ROOM OR PLATFORM.

EXTERIOR SURFACE WALL MOUNT

A

EXTERIOR SURFACE WALL MOUNT

B

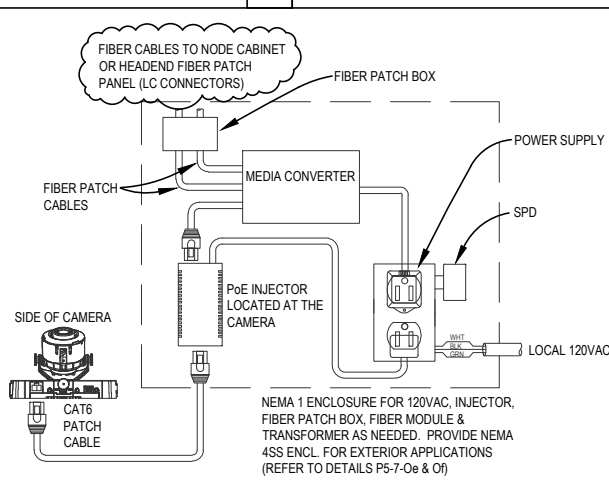
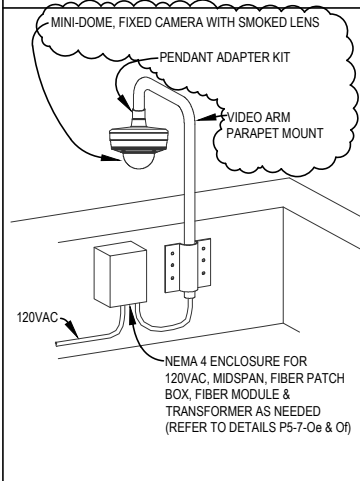

CAT6 REGULAR WIRING DETAIL

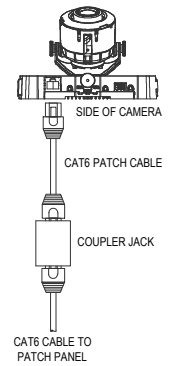

PARAPET MOUNTING DETAIL - FIBER

C

FIBER WIRING DETAIL

D

CAT6 WIRING DETAIL

E

Detail: FIXED CAMERA MOUNTING DETAILS

Fac. | Ch. | Sect. | Para. | Detail
P5-7-2 b1

CAD File: \\12 standard details\details\P5-7-2b1.dwg

Scale: NONE

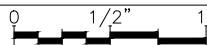

Last Revised: 10/1/2023

NOTES TO A/E:

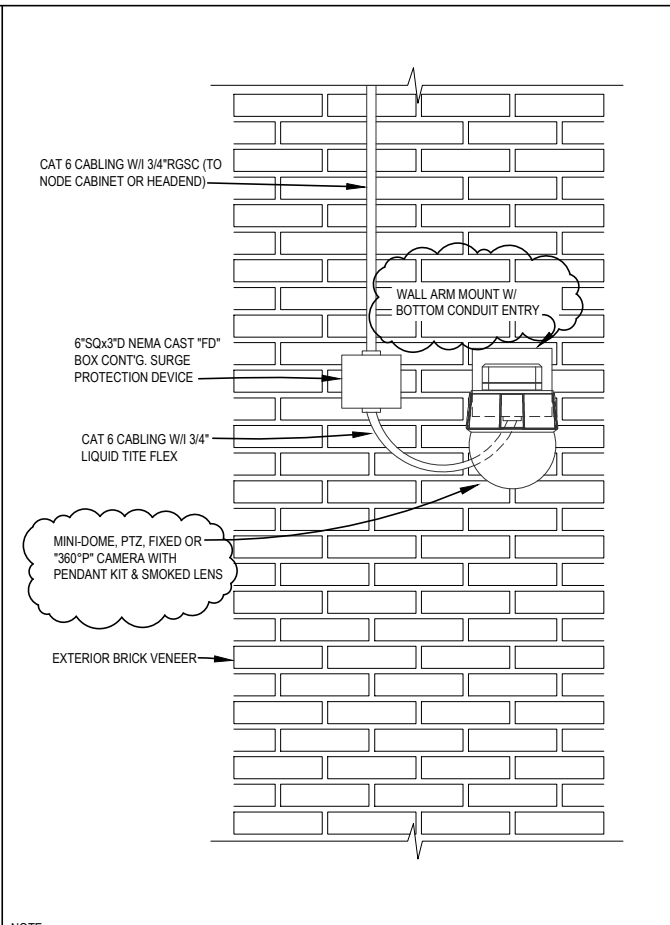
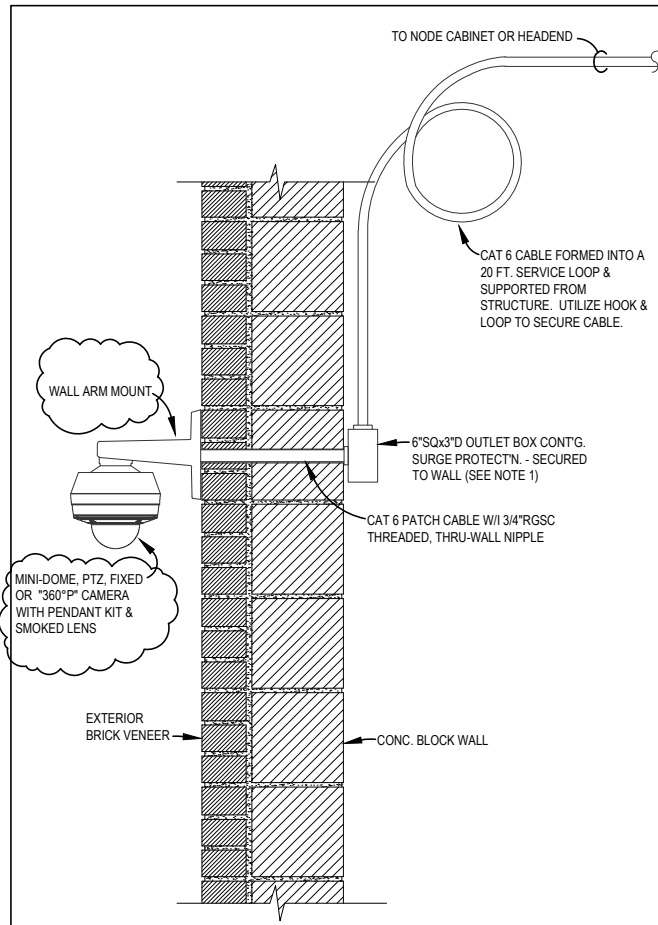

- NOTES:**
1. PROVIDE CAST AL. "FD" STYLE OUTLET BOX & 3/4"RGSC FOR ALL CAT 6 CABLING ROUTED LESS THAN 10' AFF WITHIN THE WORK ROOM OR PLATFORM.
 2. THIS DETAIL IS ALSO SIMILAR FOR THE WALL MOUNTING OF EXTERIOR FIXED & "360"° PANORAMIC CAMERAS.

- NOTE:**
1. THIS DETAIL IS ALSO SIMILAR FOR THE WALL MOUNTING OF EXTERIOR FIXED & "360"° PANORAMIC CAMERAS.

EXTERIOR WALL ARM MOUNT **A** **EXTERIOR WALL ARM MOUNT** **B**

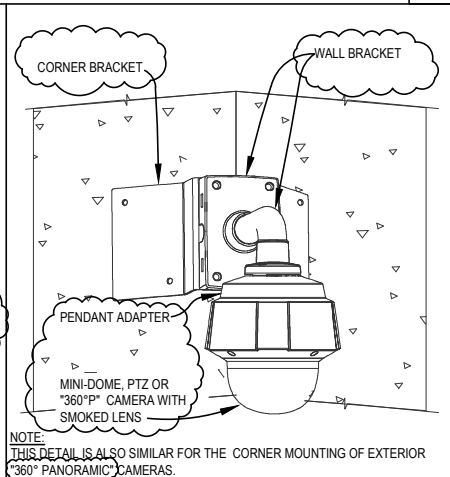
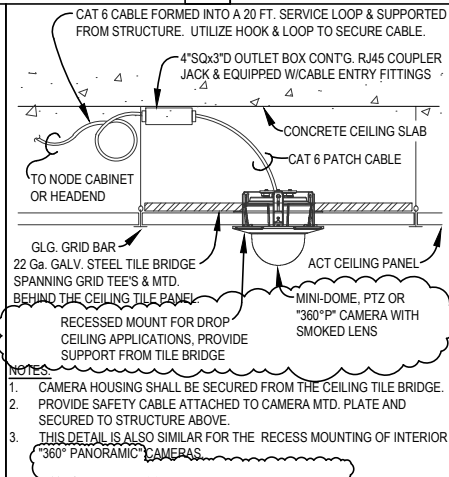
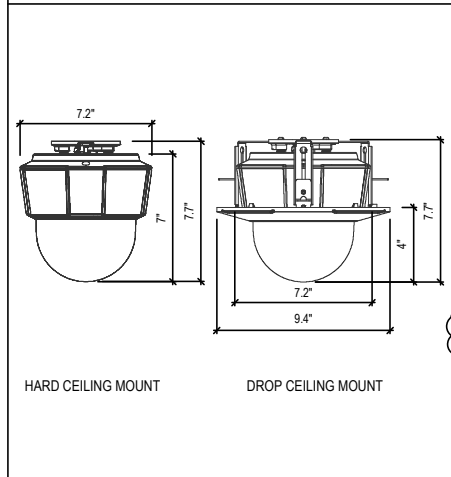

DEVICE DETAIL **C** **INTERIOR RECESSED MOUNT (ACT CEILING)** **D** **WALL CORNER MOUNTING DETAIL** **E**

Detail: **PTZ CAMERA MOUNTING DETAILS**

CAD File: \12 standard details\details\P5-7-2b2.dwg

Scale: NONE 0 1/2" 1"

Fac. | *Ch.* | *Sect.* | *Para.* | *Detail*

P5-7-2 b2

Last Revised: 10/1/2023



NOTES TO A/E:

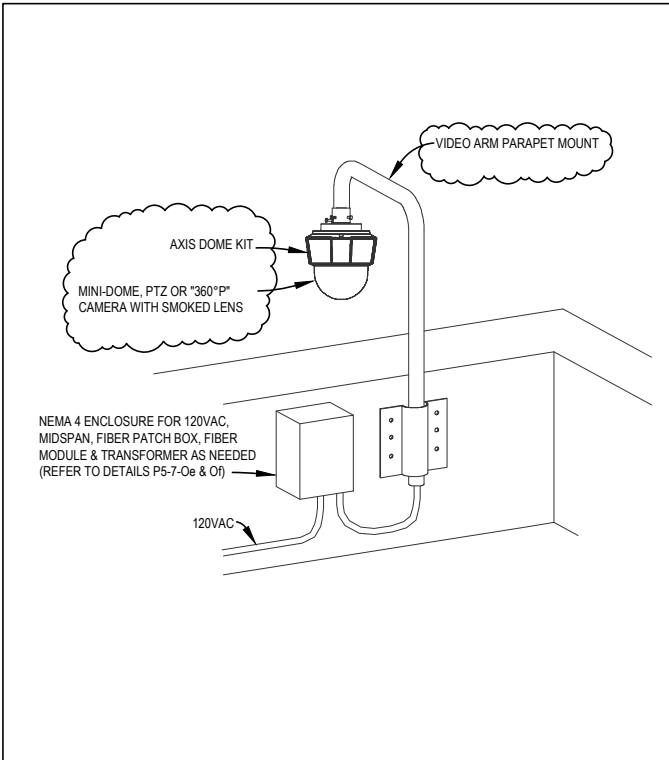

NOTE: THIS DETAIL IS ALSO SIMILAR FOR THE PARAPET MOUNTING OF THE "360° PANORAMIC" CAMERAS.

PARAPET MOUNTING DETAIL - FIBER

A

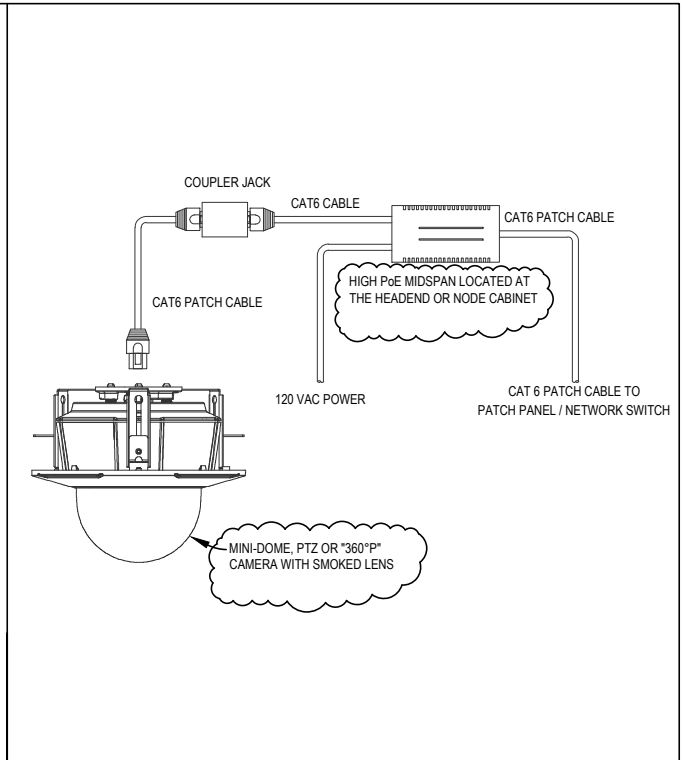

NOTE: THIS DETAIL IS ALSO SIMILAR FOR THE CAT 6 WIRING OF THE "360° PANORAMIC" CAMERAS.

CAT6 WIRING DETAIL

B

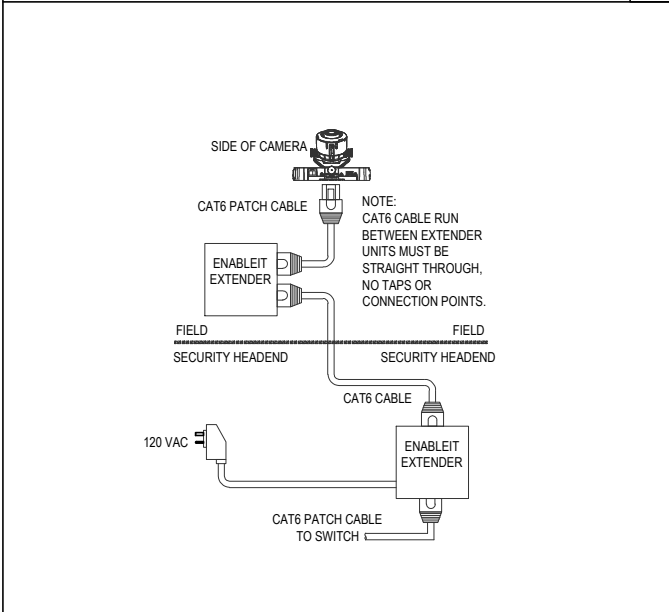

NOTE: THIS DETAIL IS ALSO SIMILAR FOR THE CAT 6 WIRING OF THE "360° PANORAMIC" CAMERAS.

CAT6 WIRING DETAILS WITH IP EXTENDER

C

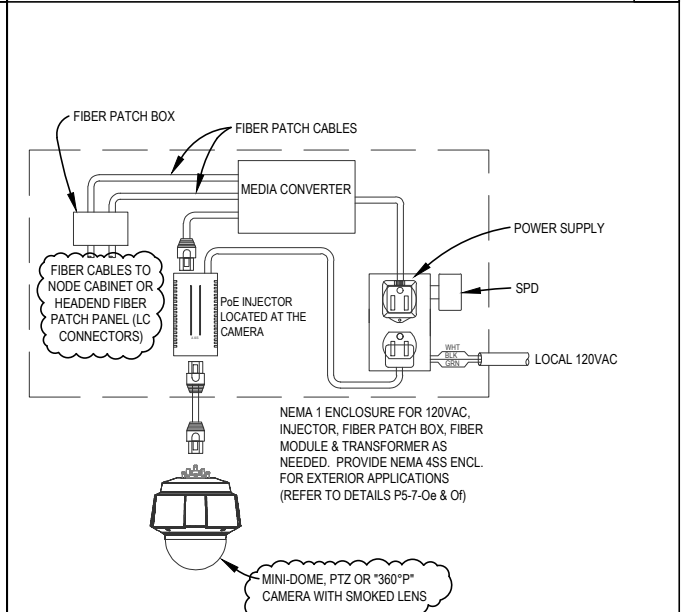

NOTE: THIS DETAIL IS ALSO SIMILAR FOR THE FIBER WIRING OF THE "360° PANORAMIC" CAMERAS.

FIBER WIRING DETAIL

D

Detail: PTZ CAMERA MOUNTING DETAILS

Fac. | Ch. | Sect. | Para. | Detail
P5-7-2 b3

CAD File: \\12 standard details\details\P5-7-2b3.dwg

Scale: NONE

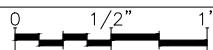

Last Revised: 10/1/2023

NOTES TO A/E:

1. ALL PENDANT MOUNTS SHALL INCORPORATE INSTALLER PROVIDED SAFETY CABLE OF SUFFICIENT ENDURANCE TO SUPPORT (2) TIMES THE WEIGHT OF THE CAMERA AND MOUNTING HARDWARE.
2. THE A/E SHALL REFER TO THE CCTV CAMERA MOUNTING PROVISIONS CONTAINED IN MODULE 2A, EXHIBITS 5-7.2.1a & 5-7.5.4a FOR APPLICABLE MTG. HEIGHTS AND SHALL NOTE THE MOUNTING HEIGHTS AND MOUNTING PROVISIONS REQUIRED FOR EACH CAMERA ON THE DESIGN DWGS..

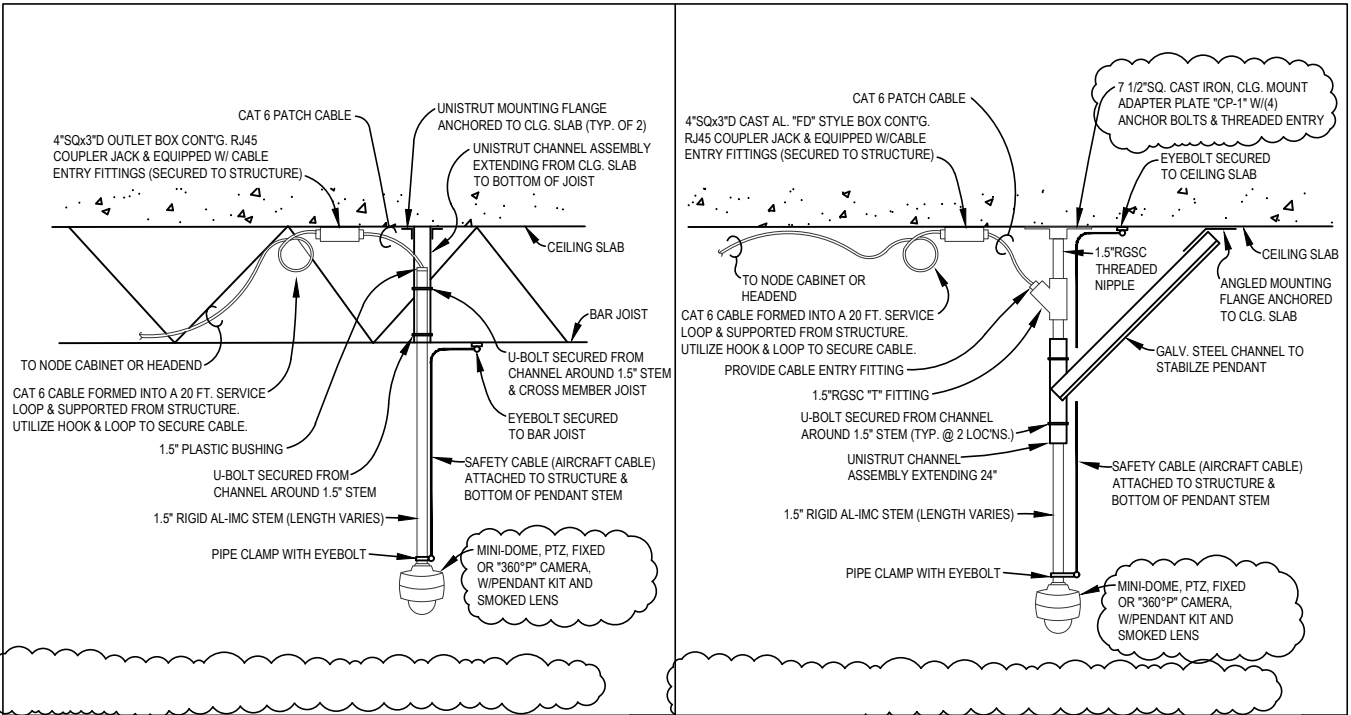

INTERIOR - WORKROOM/PLATFORM (STEM LENGTH VARIES) **A** INTERIOR - WORKROOM/PLATFORM (STEM LENGTH EXCEEDS 4FT.) **B**

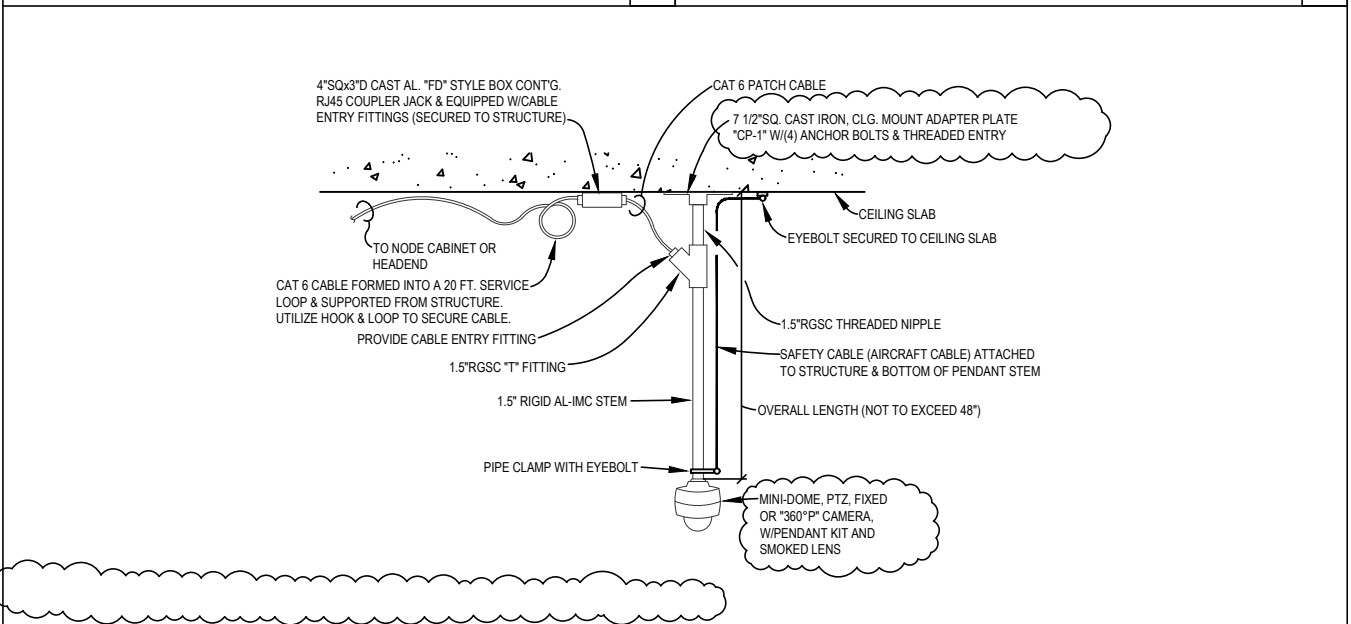

INTERIOR - WORKROOM AND PLATFORM (STEM LENGTH NOT TO EXCEED 4FT.) **C**

Detail: CEILING PENDANT MOUNTED CAMERA DETAILS		Fac.	Ch.	Sect.	Para.	Detail
CAD File: \\12 standard details\details\P5-7-2b4.dwg		Scale: NONE		0 1/2" 1"		Last Revised: 10/1/2023
						P5-7-2 b4



NOTES TO A/E:

1. ALL PENDANT MOUNTS SHALL INCORPORATE INSTALLER PROVIDED SAFETY CABLE OF SUFFICIENT ENDURANCE TO SUPPORT (2) TIMES THE WEIGHT OF THE CAMERA AND MOUNTING HARDWARE.
2. THE A/E SHALL REFER TO THE CCTV CAMERA MOUNTING PROVISIONS CONTAINED IN MODULE 2A, EXHIBITS 5-7.2.1a & 5-7.5.4a FOR APPLICABLE MTG. HEIGHTS AND SHALL NOTE THE MOUNTING HEIGHTS AND MOUNTING PROVISIONS REQUIRED FOR EACH CAMERA ON THE DESIGN DWGS..

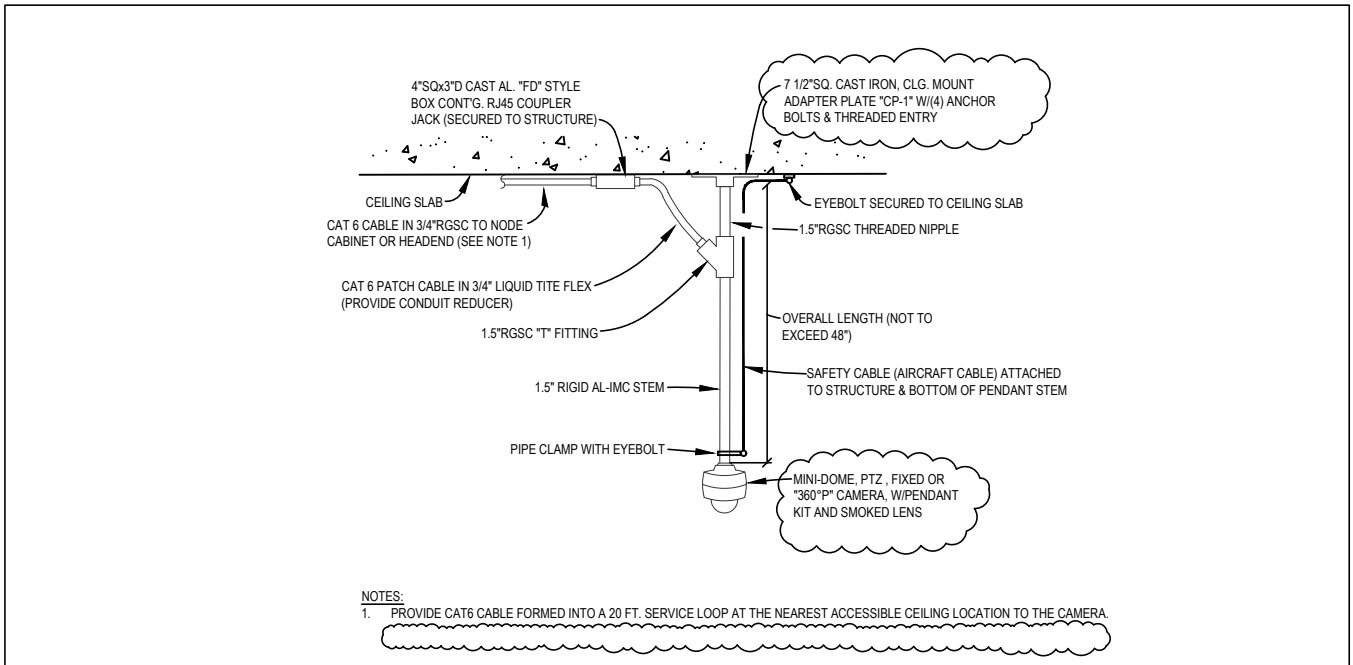

EXTERIOR - PLATFORM (STEM LENGTH NOT TO EXCEED 4 FT.)

A

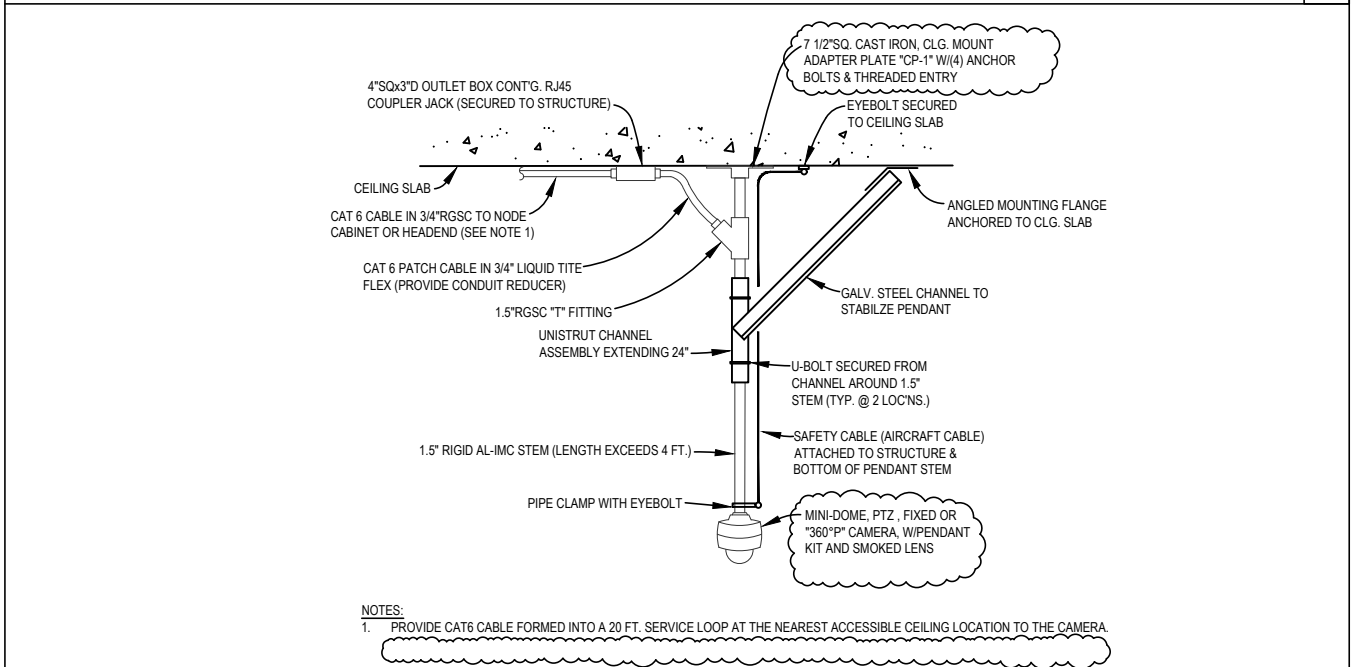

EXTERIOR - PLATFORM (STEM LENGTH EXCEEDS 4 FT.)

B

Detail:	CEILING PENDANT MOUNTED CAMERA DETAILS				Fac.	Ch.	Sect.	Para.	Detail	
					P5-7-2 b5					
CAD File:	\12 standard details\details\P5-7-2b5.dwg			Scale:	NONE		0 1/2" 1"		Last Revised:	10/1/2023

NOTES TO A/E:

1. CCTV TERMINAL CABINETS SHALL BE UTILIZED TO SERVE POLE MOUNTED CAMERAS LOCATED NO MORE THAN 50 FT. (HORIZONTALLY) FROM THE CABINET. UNDERGROUND RUNS OF CAT6/OSP/WET CABLES SERVING POLE MTD. CAMERAS IN EXCESS OF 50 FT. FROM THE TERMINAL CABINETS ARE NOT PERMITTED. CAMERAS LOCATED MORE THAN 50 FT. FROM THE TERMINAL CABINETS MUST UTILIZE FIBER CABLING AND POLE MOUNTED, NEMA 4 ENCLOSURES TO AVOID THE INCREASED RISK OF LIGHTNING INDUCED TRANSIENTS; REFER TO SDC MODULE 2A, 5-7.2.2 AND STANDARD DETAILS P5-7-0e & P5-7-0f.

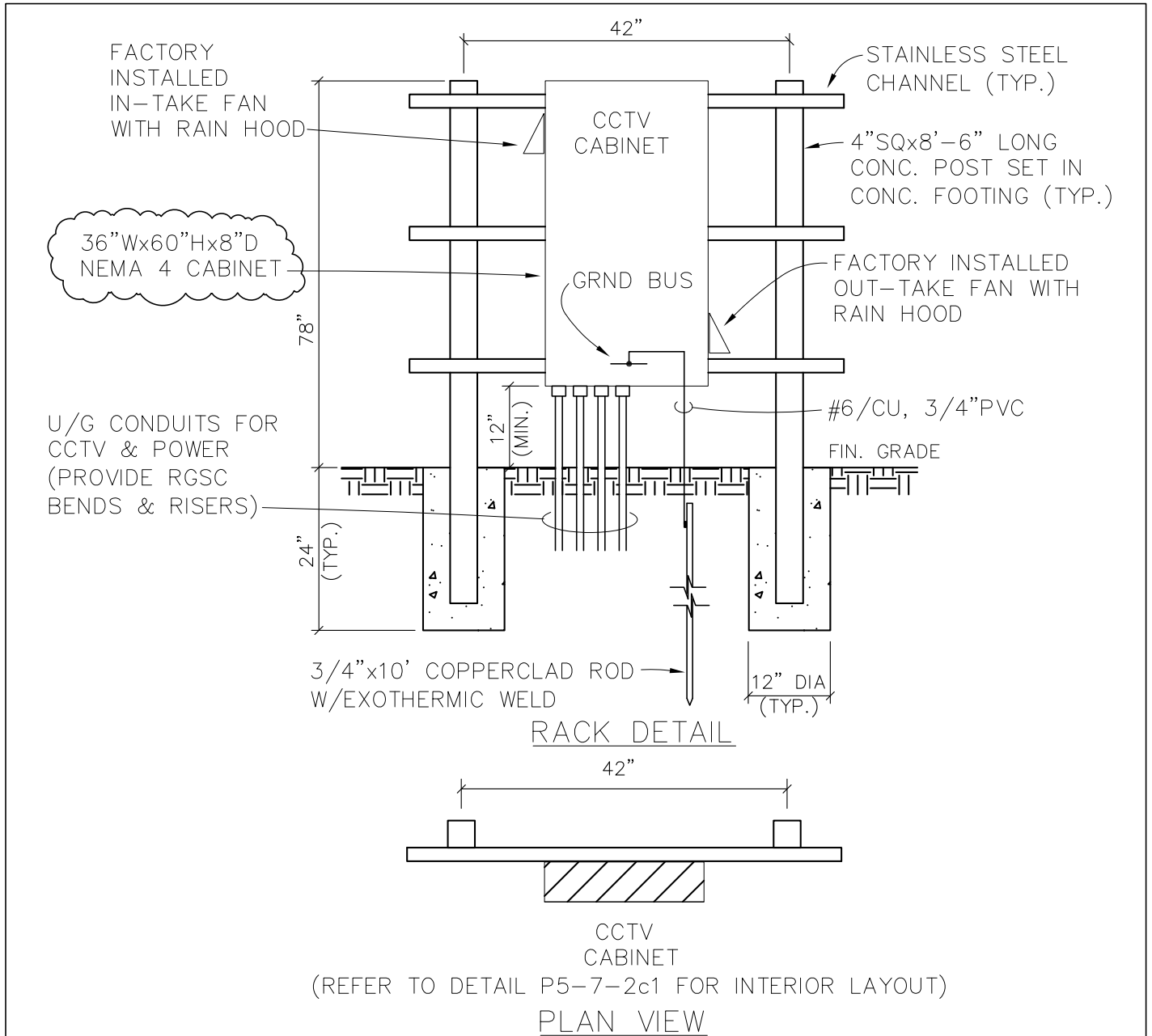

Detail: TYPICAL EXTERIOR CCTV TERMINAL CABINET (RACK MOUNTING DETAIL) CAD File: \12 standard details\details\P5-7-2c.dwg	Fac. Ch. Sect. Para. Detail P5-7-2c
	Scale: NONE 0 1/2" 1" Last Revised: 7/11/2022

NOTES TO A/E:

- THIS DETAIL DEPICTS A TYPICAL CCTV TERMINAL CABINET SERVING (6) EXTERIOR POLE MOUNTED CAMERAS AND DEFINES THE LEVEL OF QUALITY REQUIRED. THE A/E IS TO MODIFY THIS DETAIL AND CABINET DIMENSIONS BASED ON THE ACTUAL NUMBER OF CAMERAS TO BE SERVED.
- RECEPTACLES MOUNTED WITHIN THE NEMA 4 ENCLOSURE SHALL NOT BE "GFCI" TYPE.

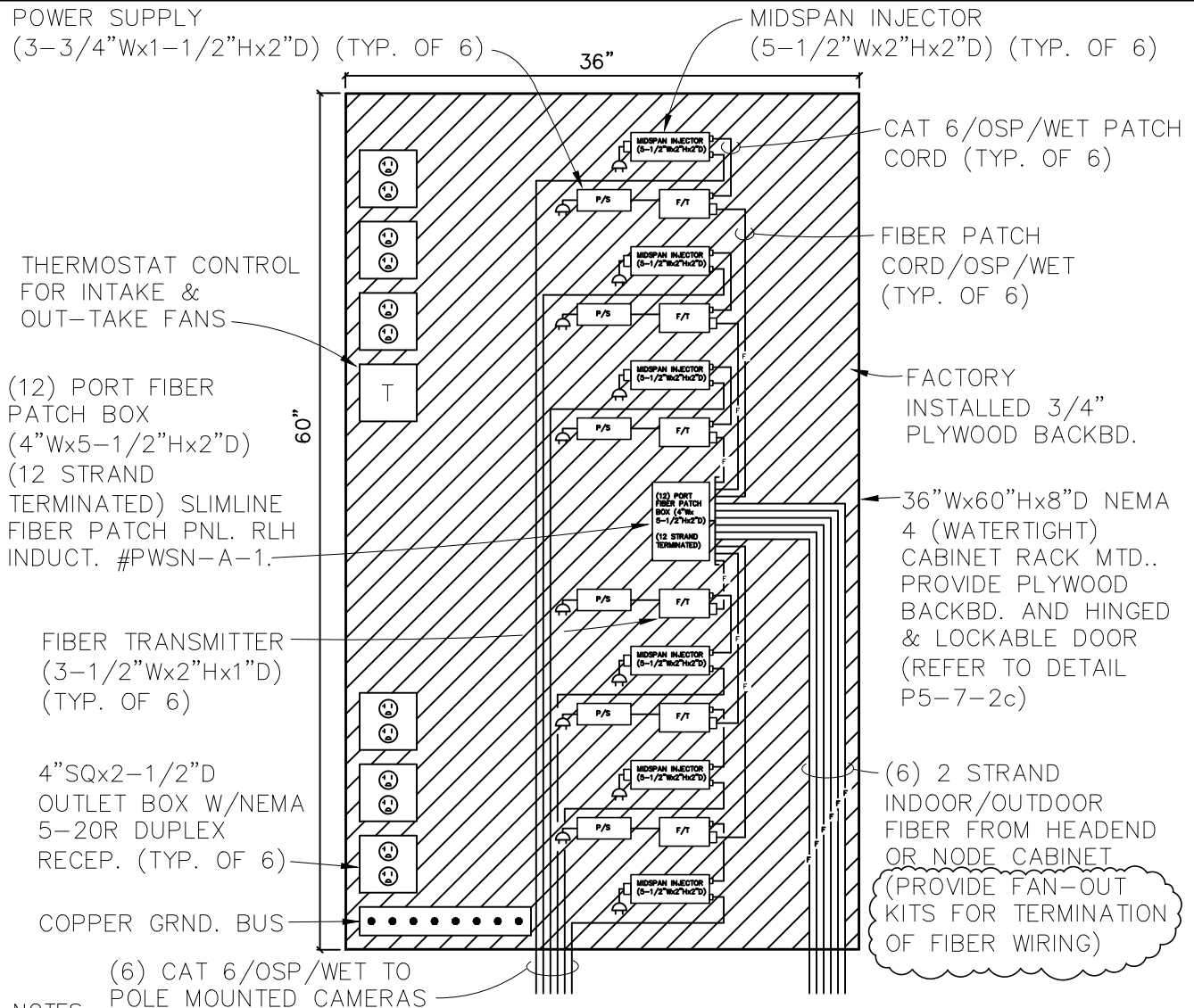

NOTES:

- ENCLOSURE SHALL BE NEMA 4 RATED STAINLESS STEEL OR NONMETALLIC, POLYCARBONATE TYPE.
- ALL COMPONENTS SHALL BE SECURELY FASTENED TO THE BACKBOARD USING FACTORY BRACKETS & APPROPRIATE WOOD SCREWS. USE OF DOUBLE SIDED, ADHESIVE HOOK & LOOP STRAPS IS NOT ACCEPTABLE. FIBER TRANSMITTERS SHALL NOT BE SECURED ATOP OF INJECTORS.
- PATCH CORDS SHALL BE AS LONG AS NECESSARY FOR THE APPLICATION BUT AS SHORT AS POSSIBLE TO AVOID LARGE CABLE BUNDLES. EXCESS CABLE LENGTHS SHALL BE PROPERLY LOOPED AND SECURED USING HOOK & LOOP STRAPS; TIE-WRAPPS ARE NOT ACCEPTABLE.
- THE 120 VOLT WIRING ROUTED W/I THE ENCLOSURE SHALL BE CONTAINED IN CONDUIT. OPEN 120 VOLT WIRING IS NOT ACCEPTABLE.
- PROVIDE 120V. SURGE PROTECTION MODULES (EDCO #FAS-100F) @ EA. DUPLEX RECEPT., (2) PER RECEPT..
- CCTV TERMINAL CABINETS SHALL NOT CONTAIN ePACS, INTERCOM OR GATE RELEASE COMPONENTS. THE CCTV SYS. SHALL UTILIZE INDEPENDENT WIRING, RACEWAYS & CABINETS.

Detail:	TYPICAL EXTERIOR CCTV TERMINAL CABINET (INTERIOR LAYOUT DETAIL)	Fac.	Ch.	Sect.	Para.	Detail
						P5-7-2 c1
CAD File:	\12 standard details\details\P5-7-2c.dwg	Scale:	1"=1'-0"	0 1/2" 1"		Last Revised: 10/1/2023

NOTES TO A/E:

1. POLES SUPPORTING CAMERAS SHALL BE EQUIPPED WITH ELEVATED CONCRETE BASES TO PROTECT FROM VEHICULAR IMPACT. REFER TO DETAILS P5-7-2a THRU 2a8.
2. ENTRANCES TO EMPLOYEE PARKING LOTS AT BASELINE SECURITY FACILITIES MUST HAVE A MOTORIZED BARRIER ARM LIFT GATE AND MANUAL SLIDING/SWING GATES. HIGH RISK LOCATIONS REQUIRE MOTORIZED SLIDING/SWING GATES, IN LIEU OF MANUAL GATES. THE BARRIER ARM LIFT GATE SHALL NOT BE PROVIDED. COORDINATE REQUIREMENTS WITH USPIS.
3. STRATEGICALLY LOCATE PROTECTIVE BARRIER PIPE BOLLARD(S) TO PROTECT CARD RDR. & INTERCOM STATION FROM VEHICULAR TRAFFIC. THE A/E SHALL INCLUDE STANDARD PIPE BOLLARD DETAIL G1-2-4g WITH THE DESIGN DWGS..
4. PROVIDE INDIVIDUAL SURGE PROTECTIVE DEVICES (POWER AND LOW VOLTAGE) AT BOTH ENDS OF ALL EXTERIOR COPPER ePACS AND INTERCOM WIRING AND ASSOCIATED WIRING EXITING THE BUILDING. SURGE SUPPRESSION SHALL BE PROVIDED FOR THE POWER & CONTROL WIRING ASSOCIATED WITH THE INTERCOM, BARRIER ARM GATES, SLIDING GATES (IF MOTORIZED) EXTERIOR READER INTERFACE MODULES & POWER SUPPLIES. REFER TO MPF SPECIFICATION SECTION 281304.
5. REFER TO DETAIL P1-2-4h FOR APPLICABLE SITE DIMENSIONS AND REQUIREMENTS.
6. CAMERA FINAL MOUNTING HEIGHTS SHALL BE CHOSEN TO SUIT THE APPLICATION.

SPECIFIC NOTES

- 1 PROVIDE FIXED CAMERA TO VIEW FRONT LICENSE PLATE OF VEHICLE. POLE MOUNTED TOP @ 11' TO 20' AFG.. PROVIDE STEEL POLE WITH CONCRETE BASE SIZED FOR APPROPRIATE WIND LOADING.
- 2 PROVIDE (1) LONG RANGE CARD READER & (1) VIDEO/INTERCOM STATION @ 54" AFG., PEDESTAL MOUNT AS SHOWN ON STANDARD DETAIL P5-7-4a1.
- 3 MOTORIZED SLIDING/SWING GATES REQUIRED AT HIGH RISK FACILITIES SHALL BE EQUIPPED WITH (3) VEHICLE SENSOR LOOPS FOR EACH LANE. BARRIER ARM LIFT GATES SHALL NOT BE PROVIDED AT HIGH RISK LOCATIONS.
- 4 PROVIDE FIXED CAMERA TO VIEW REAR LICENSE PLATE OF VEHICLE. POLE MOUNTED TOP @ 11' TO 20' AFG. PROVIDE STEEL POLE WITH CONCRETE BASE SIZED FOR APPROPRIATE WIND LOADING.

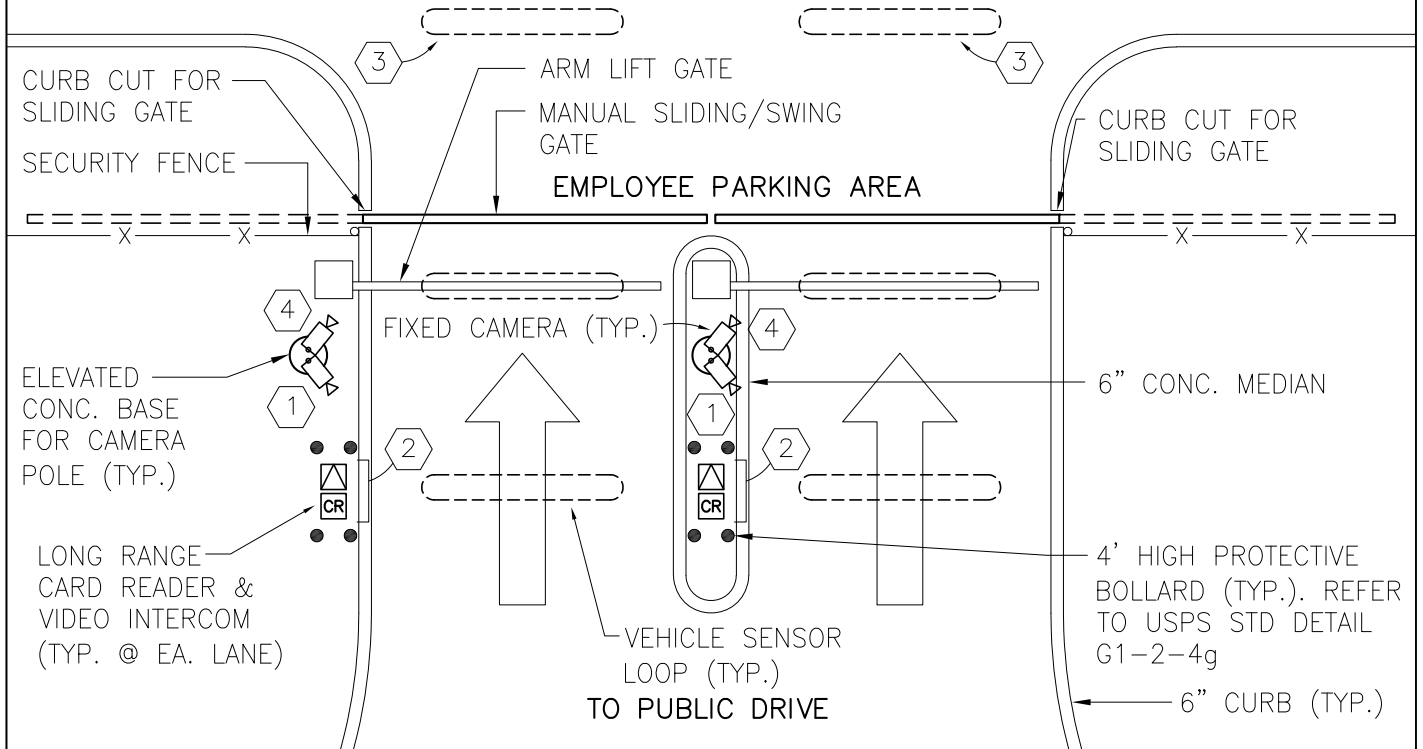

Detail: ePACS - INBOUND EMPLOYEE PARKING ENTRANCE					Fac.	Ch.	Sect.	Para.	Detail
					P5-7-4 a				
CAD File: \12 standard details\details\P5-7-4a.dwg					Scale: 1/8" = 1'-0"				
					Last Revised: 7/2/2021				

NOTES TO A/E:

1. POLES SUPPORTING CAMERAS SHALL BE EQUIPPED WITH ELEVATED CONCRETE BASES TO PROTECT FROM VEHICULAR IMPACT. REFER TO DETAILS P5-7-2a THRU 2a8.
2. EXITS FROM EMPLOYEE PARKING LOTS AT BASELINE SECURITY FACILITIES MUST HAVE A MOTORIZED BARRIER ARM LIFT GATE AND MANUAL SLIDING/SWING GATES. HIGH RISK LOCATIONS REQUIRE MOTORIZED SLIDING/SWING GATES, IN LIEU OF MANUAL GATES. THE BARRIER ARM LIFT GATE SHALL NOT BE PROVIDED. COORDINATE REQUIREMENTS WITH USPIS.
3. PROVIDE INDIVIDUAL SURGE PROTECTIVE DEVICES (POWER AND LOW VOLTAGE) AT BOTH ENDS OF ALL EXTERIOR COPPER ePACS WIRING AND ASSOCIATED WIRING EXITING THE BUILDING. SURGE SUPPRESSION SHALL BE PROVIDED FOR THE POWER & CONTROL WIRING ASSOCIATED WITH THE BARRIER ARM GATES AND SLIDING GATES (IF MOTORIZED). REFER TO MPF SPECIFICATION SECTION 281304.
4. REFER TO DETAIL P1-2-4i FOR APPLICABLE SITE DIMENSIONS AND REQUIREMENTS.
5. CAMERA FINAL MOUNTING HEIGHTS SHALL BE CHOSEN TO SUIT THE APPLICATION.

SPECIFIC NOTES

- 1 PROVIDE FIXED CAMERA TO VIEW FRONT LICENSE PLATE OF VEHICLE. POLE MOUNTED TOP @ 11' TO 20' AFG.. PROVIDE STEEL POLE WITH CONCRETE BASE SIZED FOR APPROPRIATE WIND LOADING.
- 2 MOTORIZED SLIDING/SWING GATES REQUIRED AT HIGH RISK FACILITIES SHALL BE EQUIPPED WITH (3) VEHICLE SENSOR LOOPS FOR EACH LANE. BARRIER ARM LIFT GATES SHALL NOT BE PROVIDED AT HIGH RISK LOCATIONS.

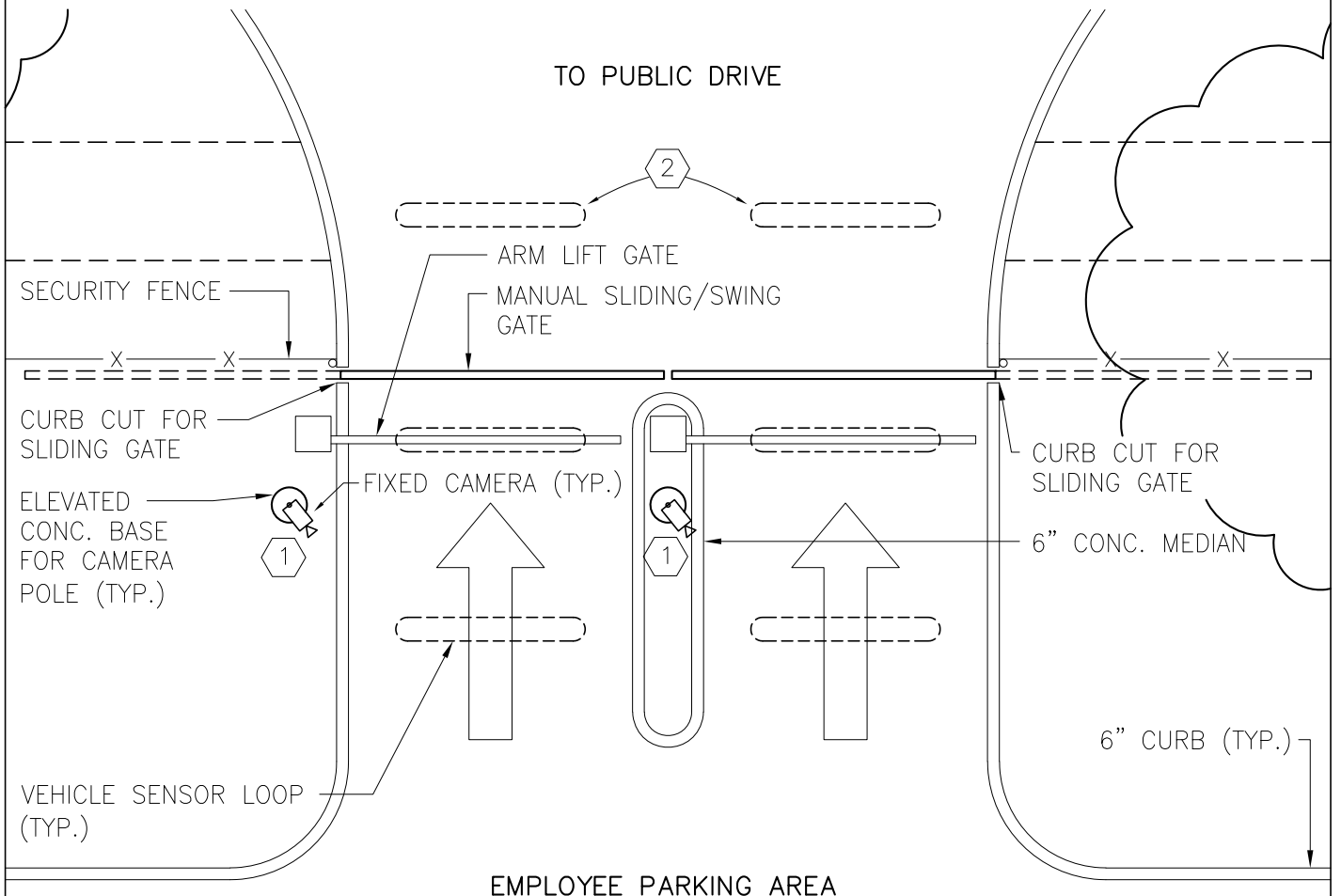

Detail: ePACS - EMPLOYEE PARKING EXIT		Fac.	Ch.	Sect.	Para.	Detail
		P5-7-4b				
CAD File: ..\usps\library\details\P5-7-4b.dwg	Scale: 1/8"=1'-0"	0		8"		16"
Last Revised: 7/2/2021						



STANDARD DETAIL LIBRARY

NOTES TO A/E:

1. PROVIDE LONG RANGE RDR. & INTERCOM ONLY AT FACILITIES WHERE LLV'S ARE OPERATED. ALL DEVICES MOUNTED AT 54" AFG., PEDESTAL MOUNT AS SHOWN ON STANDARD DETAIL P5-7-4a1.
2. POLES SUPPORTING CAMERAS SHALL BE EQUIPPED WITH ELEVATED CONCRETE BASES TO PROTECT FROM VEHICULAR IMPACT. REFER TO DETAILS P5-7-2a THRU 2a8.
3. STRATEGICALLY LOCATE PROTECTIVE BARRIER PIPE BOLLARD(S) TO PROTECT CARD RDR & INTERCOM STATION FROM VEHICULAR TRAFFIC. THE A/E SHALL INCLUDE STANDARD PIPE BOLLARD DETAIL G1-2-4g1 WITH THE DESIGN DWGS..
4. PROVIDE INDIVIDUAL SURGE PROTECTIVE DEVICES (POWER AND LOW VOLTAGE) AT BOTH ENDS OF ALL EXTERIOR COPPER ePACS & INTERCOM WIRING AND ASSOCIATED WIRING EXITING THE BUILDING. SURGE SUPPRESSION SHALL BE PROVIDED FOR THE POWER & CONTROL WIRING ASSOCIATED WITH THE INTERCOM, SLIDING GATES, EXTERIOR READER INTERFACE MODULES AND POWER SUPPLIES. REFER TO MPF SPECIFICATION SECTION 281304.
5. REFER TO DETAIL P1-2-4m FOR APPLICABLE SITE DIMENSIONS AND REQUIREMENTS.
6. CAMERA FINAL MOUNTING HEIGHTS SHALL BE CHOSEN TO SUIT THE APPLICATION.

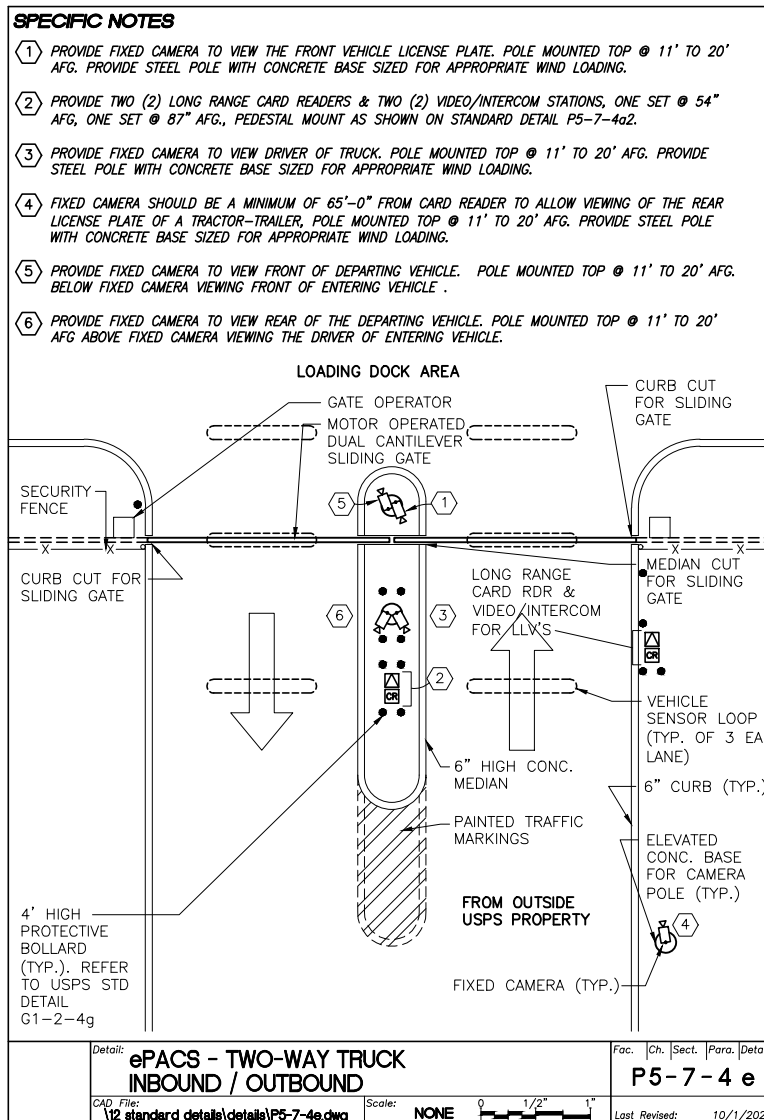

Detail: ePACS - TWO-WAY TRUCK INBOUND / OUTBOUND	Fac. Ch. Sect. Para. Detail P5-7-4 e
CAD File: \\12 standard details\details\P5-7-4e.dwg	Scale: NONE
Last Revised: 10/1/2023	



NOTES TO A/E:

1. STRATEGICALLY LOCATE PROTECTIVE BARRIER PIPE BOLLARDS TO PROTECT CARD RDR. & INTERCOM STATION FROM VEHICULAR IMPACT. THE A/E SHALL INCLUDE STANDARD PIPE BOLLARD DETAIL G1-2-4g WITHIN THE DESIGN DWGS.
2. DIMENSIONS AND SIZINGS SHOWN ARE PROVIDED FOR GENERAL INTENT ONLY AND INDICATE THE RESULT TO BE ACHIEVED. ACTUAL DIMENSIONS AND SIZINGS SHALL REFLECT INDIVIDUAL SITE CONDITIONS.
3. MOUNTING HEIGHTS OF CARD RDRS. & INTERCOM CALL-IN STATIONS ARE CRITICAL. COORDINATE THE ACTUAL MOUNTING HEIGHTS WITH ACTUAL SITE CONDITIONS.

NOTES

1. SUBMIT DETAILED AND COMPREHENSIVE FABRICATION DRAWINGS FOR APPROVAL. DRAWINGS SHALL INCLUDE MATERIALS, ELECT. DEVICES, DEVICE ATTACHMENT, HARDWARE SIZES, CLEARANCES, CONDUIT ENTRY, ARRANGEMENT OF ALL COMPONENTS AND OVERALL COORDINATION.
2. ALL MOUNTING HARWARE SHALL BE STAINLESS STEEL TYPE STANDARD MACHINE THREAD. SELF-TAPPING SCREWS ARE NOT ACCEPTABLE. DRILL AND TAP ALL ATTACHMENTS.
3. STRATEGICALLY LOCATE PROTECTIVE PIPE BOLLARDS TO PROTECT PEDESTAL & DEVICES FROM VEHICLE IMPACT. REFER TO DETAIL G1-2-4g.

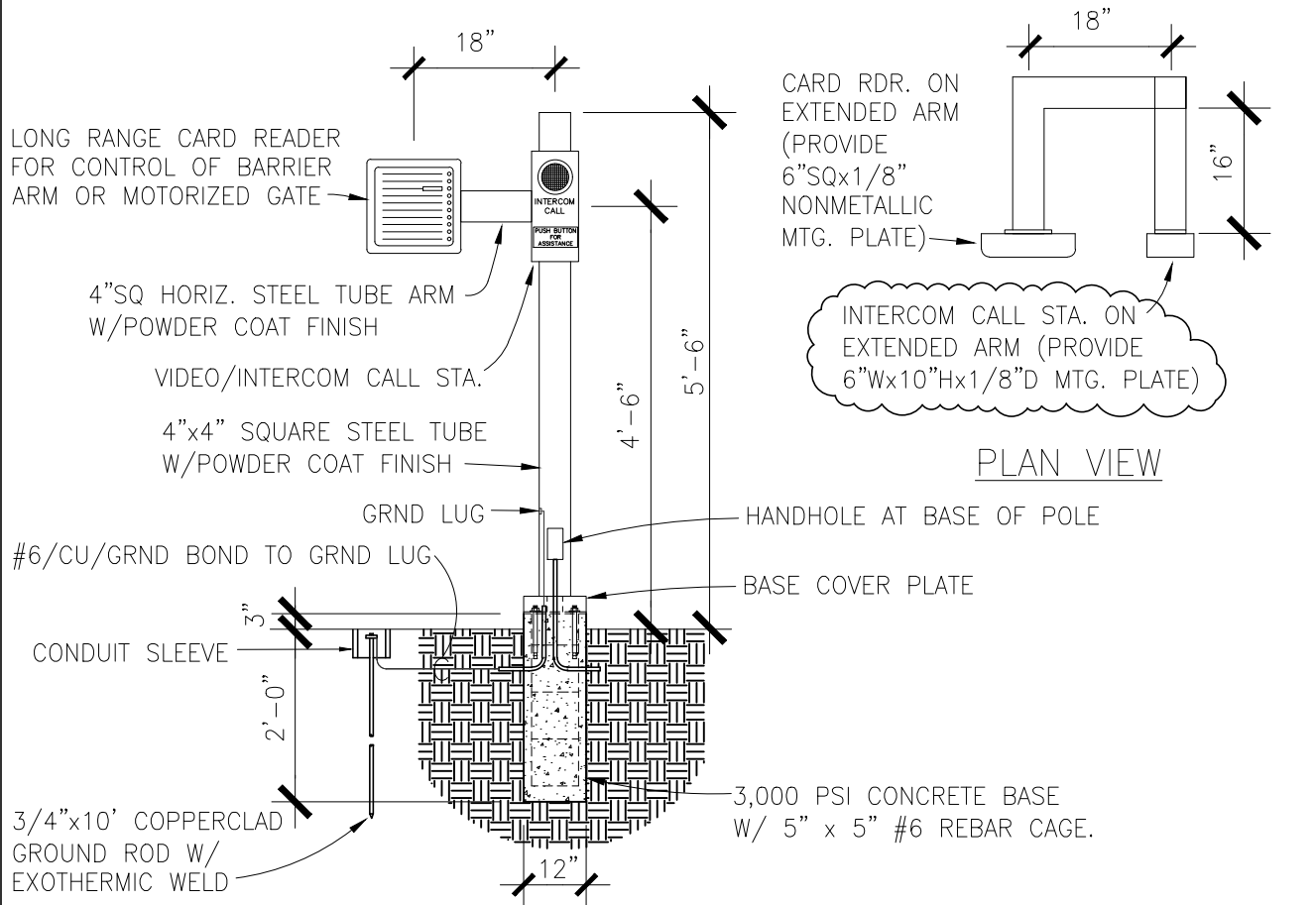

Detail: CARD READER SINGLE PEDESTAL MOUNTING - DETAIL	Fac. Ch. Sect. Para. Detail P5-7-4 a1
	CAD File: \12 standard details\details\P5-7-4a1.dwg Scale: NTS 0 1/2" 1" Last Revised: 10/1/2023

NOTES TO A/E:

1. STRATEGICALLY LOCATE PROTECTIVE BARRIER PIPE BOLLARDS TO PROTECT CARD RDR. & INTERCOM STATION @ TRUCK ENTRY FROM VEHICULAR IMPACT. THE A/E SHALL INCLUDE STANDARD PIPE BOLLARD DETAIL G1-2-4g1 WITHIN THE DESIGN DWGS.
2. DIMENSIONS AND SIZINGS SHOWN ARE PROVIDED FOR GENERAL INTENT ONLY AND INDICATE THE RESULT TO BE ACHIEVED. ACTUAL DIMENSIONS AND SIZINGS SHALL REFLECT INDIVIDUAL SITE CONDITIONS.
3. MOUNTING HEIGHTS OF CARD RDRS. & INTERCOM CALL-IN STATIONS ARE CRITICAL. COORDINATE THE ACTUAL MOUNTING HEIGHTS WITH ACTUAL SITE CONDITIONS.

NOTES

1. SUBMIT DETAILED AND COMPREHENSIVE FABRICATION DRAWINGS FOR APPROVAL. DRAWINGS SHALL INCLUDE MATERIALS, ELECT. DEVICES, DEVICE ATTACHMENT, HARDWARE SIZES, CLEARANCES, CONDUIT ENTRY, ARRANGEMENT OF ALL COMPONENTS AND OVERALL COORDINATION.
2. ALL MOUNTING HARWARE SHALL BE STAINLESS STEEL TYPE STANDARD MACHINE THREAD. SELF-TAPPING SCREWS ARE NOT ACCEPTABLE. DRILL AND TAP ALL ATTACHMENTS.
3. STRATEGICALLY LOCATE PROTECTIVE PIPE BOLLARDS TO PROTECT PEDESTAL & DEVICES FROM VEHICLE IMPACT. REFER TO DETAIL G1-2-4g1.

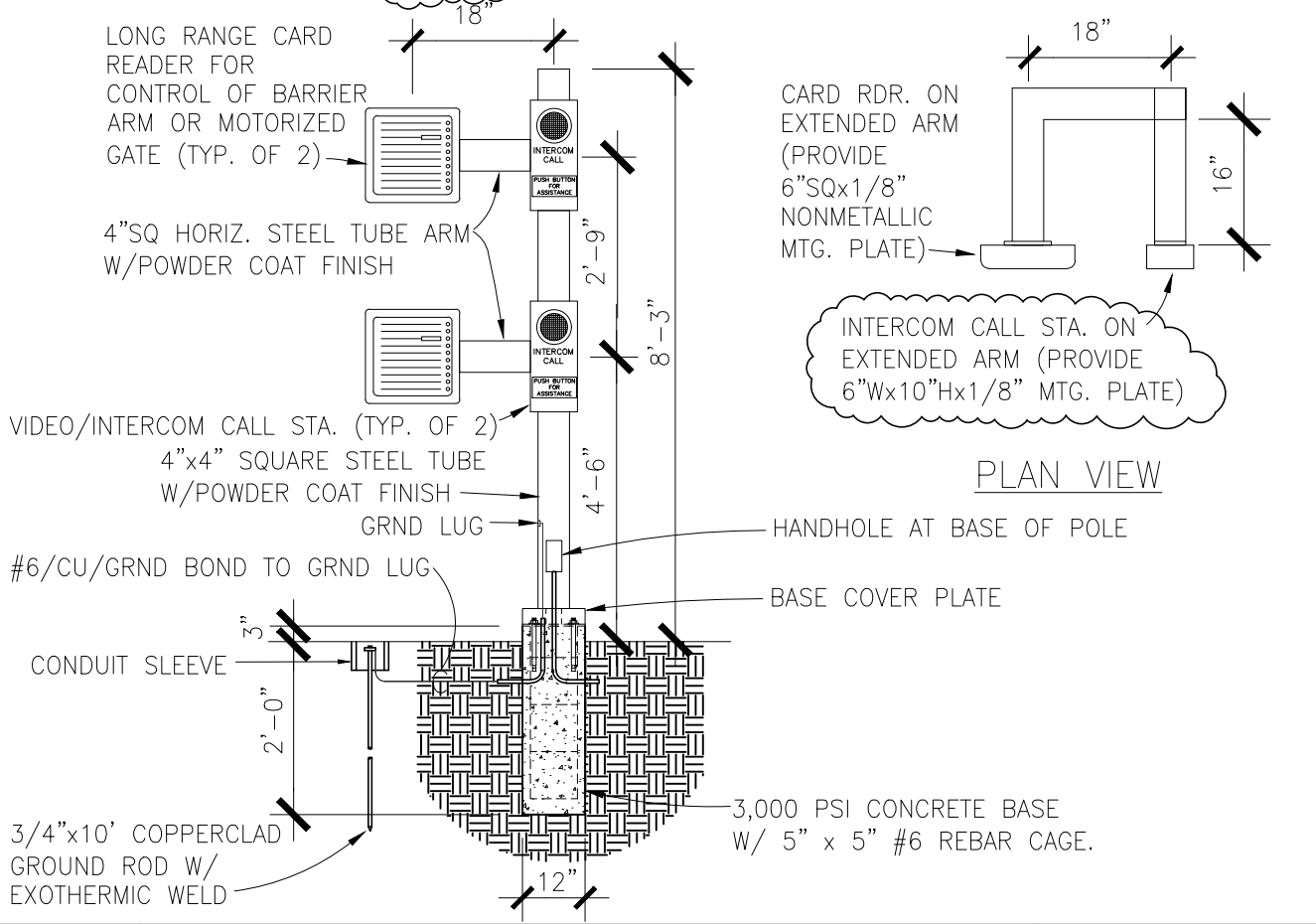

Detail: CARD READER DOUBLE PEDESTAL MOUNTING - DETAIL		Fac. Ch. Sect. Para. Detail P5-7-4 a2
CAD File: \12 standard details\details\P5-7-4a2.dwg	Scale: NTS 	Last Revised: 10/1/2023

© Copyright 1997-2015 United States Postal Service



STANDARD DETAIL LIBRARY

NOTES TO A/E:

1. PROVIDE LONG RANGE CARD RDR. & INTERCOM ONLY AT FACILITIES WHERE LLV'S ARE OPERATED. ALL DEVICES MOUNTED AT 54" AFG., PEDESTAL MOUNT AS SHOWN ON STANDARD DETAIL P5-7-4a1.
2. POLES SUPPORTING CAMERAS SHALL BE EQUIPPED WITH ELEVATED CONCRETE BASES TO PROTECT FROM VEHICULAR IMPACT. REFER TO DETAILS P5-7-2a THRU 2a8.
3. STRATEGICALLY LOCATE PROTECTIVE BARRIER PIPE BOLLARD(S) TO PROTECT RDR & INTERCOM STATION FROM VEHICULAR TRAFFIC. THE A/E SHALL INCLUDE STANDARD PIPE BOLLARD DETAIL *G1-2-4g1* WITH THE DESIGN DWGS..
4. PROVIDE INDIVIDUAL SURGE PROTECTIVE DEVICES (POWER AND LOW VOLTAGE) AT BOTH ENDS OF ALL EXTERIOR COPPER ePACS AND INTERCOM WIRING AND ASSOCIATED WIRING EXITING THE BUILDING. SURGE SUPPRESSION SHALL BE PROVIDED FOR THE POWER & CONTROL WIRING ASSOCIATED WITH THE INTERCOM, SLIDING GATES, EXTERIOR READER INTERFACE MODULES AND POWER SUPPLIES. REFER TO MPF SPECIFICATON SECTION 281304.
5. REFER TO DETAIL P1-2-4k FOR APPLICABLE SITE DIMENSIONS AND REQUIREMENTS.
6. CAMERA FINAL MOUNTING HEIGHTS SHALL BE CHOSEN TO SUIT THE APPLICATION.

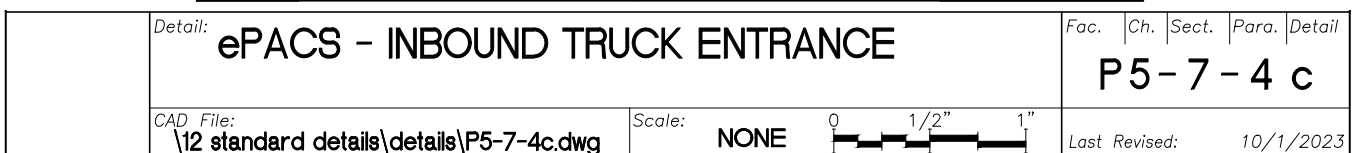
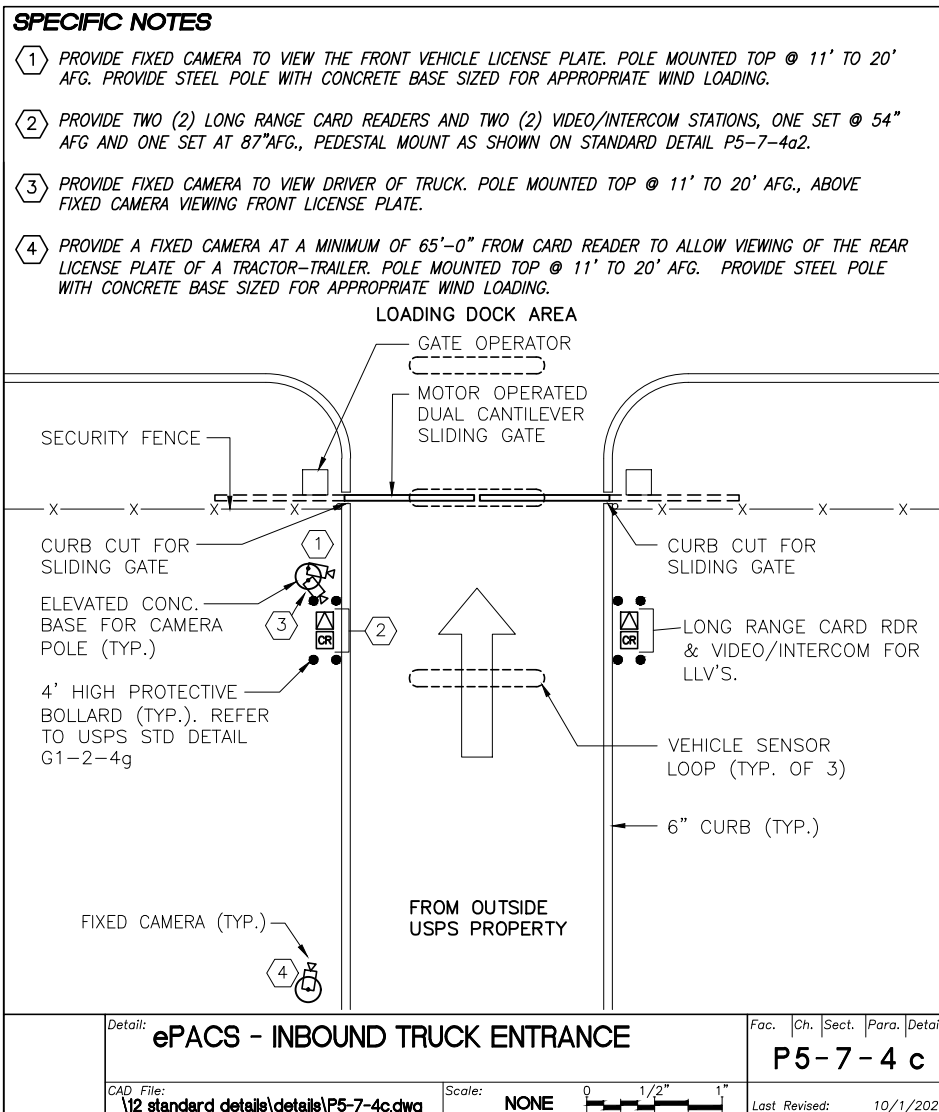

NOTES TO A/E:

1. POLES SUPPORTING CAMERAS SHALL BE EQUIPPED WITH ELEVATED CONCRETE BASES TO PROTECT FROM VEHICULAR IMPACT. REFER TO DETAILS P5-7-2a THRU 2a8.
2. PROVIDE INDIVIDUAL SURGE PROTECTIVE DEVICES (POWER AND LOW VOLTAGE) AT BOTH ENDS OF ALL EXTERIOR COPPER ePACS WIRING AND ASSOCIATED WIRING EXITING THE BUILDING. SURGE SUPPRESSION SHALL BE PROVIDED FOR THE POWER & CONTROL WIRING ASSOCIATED WITH THE SLIDING GATES. REFER TO MPF SPECIFICATION SECTION 281304.
3. REFER TO DETAIL P1-2-4I FOR APPLICABLE SITE DIMENSIONS AND REQUIREMENTS.
4. CAMERA FINAL MOUNTING HEIGHTS SHALL BE CHOSEN TO SUIT THE APPLICATION.

SPECIFIC NOTES

- ① PROVIDE FIXED CAMERA TO VIEW FRONT OF VEHICLE. POLE MOUNTED TOP @ 11' TO 20' AFG. PROVIDE STEEL POLE WITH CONCRETE BASE SIZED FOR APPROPRIATE WIND LOADING.
- ② PROVIDE FIXED CAMERA TO VIEW REAR OF DEPARTING VEHICLE. POLE MOUNTED TOP @ 11' TO 20' AFG ABOVE FIXED CAMERA VIEWING FRONT OF VEHICLE

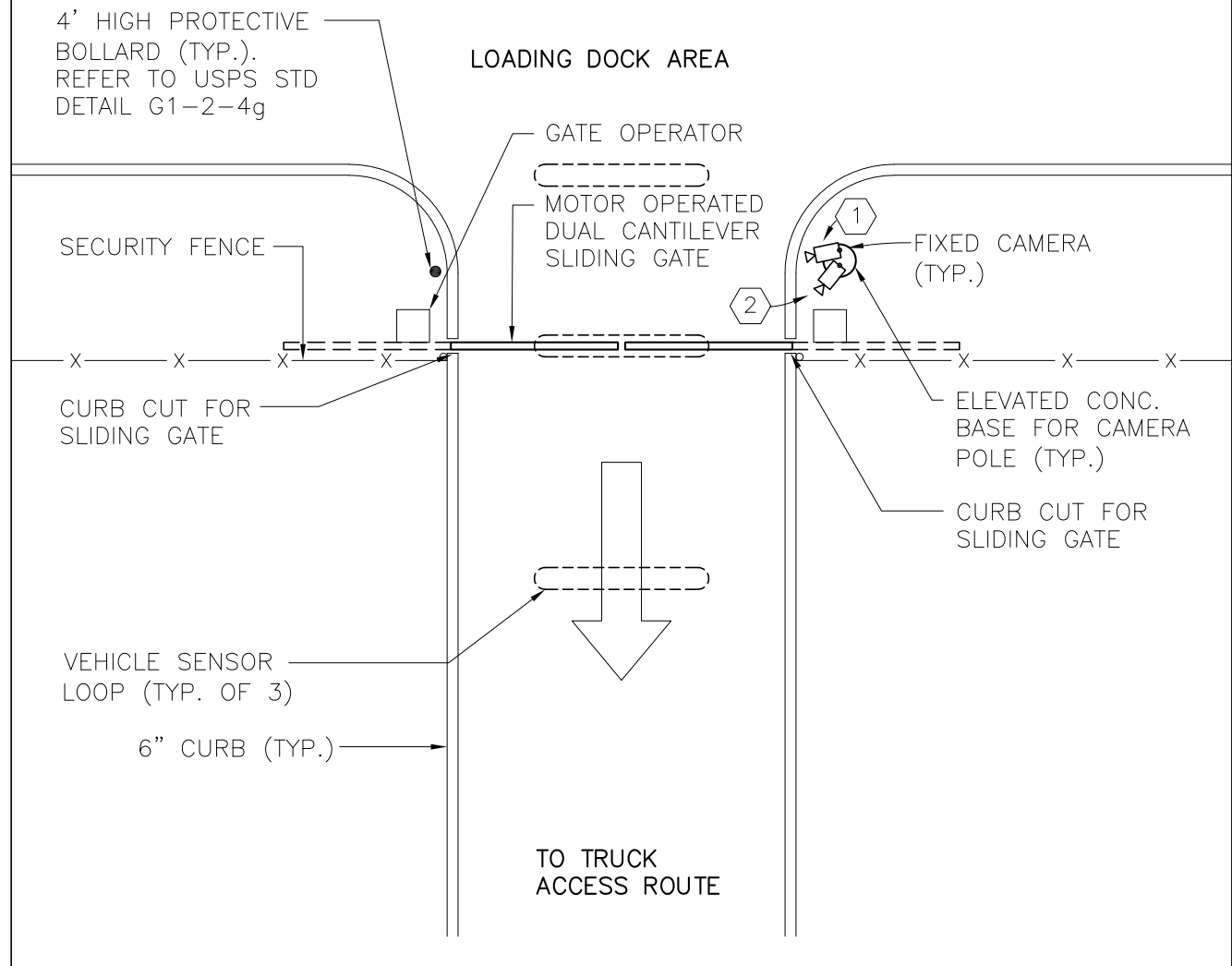

Detail: ePACS - OUTBOUND TRUCK EXIT		Fac.	Ch.	Sect.	Para.	Detail
		P5-7-4 d				
CAD File:	Scale:	0		1/2"	1"	Last Revised:
12 standard details\details\P5-7-4d.dwg	1/8"=1'-0"					7/2/2021

NOTES TO A/E:

1. PROVIDE LONG RANGE CARD RDR. & INTERCOM ONLY AT FACILITIES WHERE LLV'S ARE OPERATED. ALL DEVICES MOUNTED AT 54" AFG., PEDESTAL MOUNT AS SHOWN ON STANDARD DETAIL P5-7-4a1.
2. POLES SUPPORTING CAMERAS SHALL BE EQUIPPED WITH ELEVATED CONCRETE BASES TO PROTECT FROM VEHICULAR IMPACT. REFER TO DETAILS P5-7-2a THRU 2a8.
3. STRATEGICALLY LOCATE PROTECTIVE BARRIER PIPE BOLLARD(S) TO PROTECT RDR & INTERCOM STATION FROM VEHICULAR TRAFFIC. THE A/E SHALL INCLUDE STANDARD PIPE BOLLARD DETAIL *G1-2-4g1* WITH THE DESIGN DWGS..
4. PROVIDE INDIVIDUAL SURGE PROTECTIVE DEVICES (POWER AND LOW VOLTAGE) AT BOTH ENDS OF ALL EXTERIOR COPPER ePACS AND INTERCOM WIRING AND ASSOCIATED WIRING EXITING THE BUILDING. SURGE SUPPRESSION SHALL BE PROVIDED FOR THE POWER & CONTROL WIRING ASSOCIATED WITH THE INTERCOM, SLIDING GATES, EXTERIOR READER INTERFACE MODULES AND POWER SUPPLIES. REFER TO MPF SPECIFICATON SECTION 281304.
5. REFER TO DETAIL P1-2-4k FOR APPLICABLE SITE DIMENSIONS AND REQUIREMENTS.
6. CAMERA FINAL MOUNTING HEIGHTS SHALL BE CHOSEN TO SUIT THE APPLICATION.

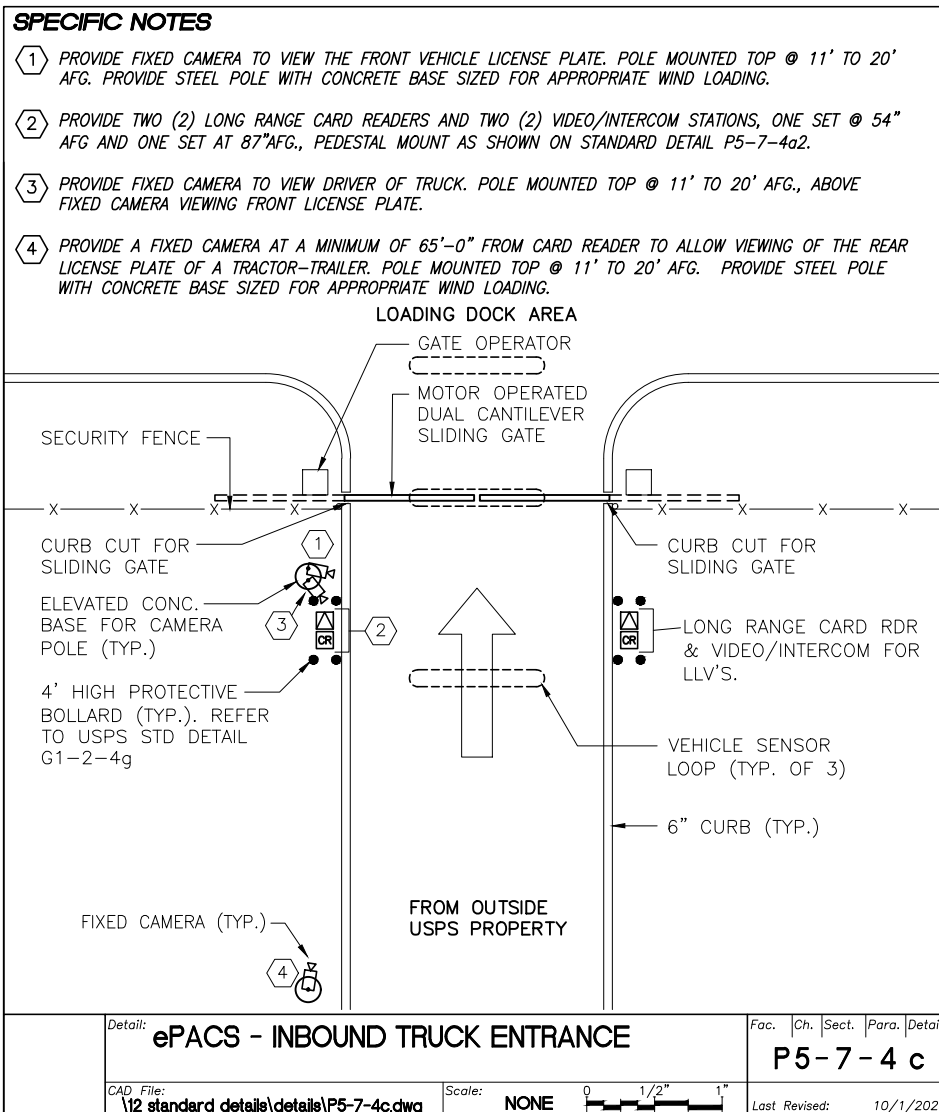

Detail:	ePACS - INBOUND TRUCK ENTRANCE	Fac.	Ch.	Sect.	Para.	Detail
						P5-7-4 c
CAD File:	\\12 standard details\details\P5-7-4c.dwg	Scale:	NONE	0 1/2" 1"		Last Revised: 10/1/2023

NOTES TO A/E:

1. PROVIDE LONG RANGE CARD RDR. & INTERCOM ONLY AT FACILITIES WHERE LLV'S ARE OPERATED. ALL DEVICES MOUNTED AT 54" AFG., PEDESTAL MOUNT AS SHOWN ON STANDARD DETAIL P5-7-4a1.
2. POLES SUPPORTING CAMERAS SHALL BE EQUIPPED WITH ELEVATED CONCRETE BASES TO PROTECT FROM VEHICULAR IMPACT. REFER TO DETAILS P5-7-2a THRU 2a8.
3. STRATEGICALLY LOCATE PROTECTIVE BARRIER PIPE BOLLARD(S) TO PROTECT RDR & INTERCOM STATION FROM VEHICULAR TRAFFIC. THE A/E SHALL INCLUDE STANDARD PIPE BOLLARD DETAIL *G1-2-4g1* WITH THE DESIGN DWGS..
4. PROVIDE INDIVIDUAL SURGE PROTECTIVE DEVICES (POWER AND LOW VOLTAGE) AT BOTH ENDS OF ALL EXTERIOR COPPER ePACS AND INTERCOM WIRING AND ASSOCIATED WIRING EXITING THE BUILDING. SURGE SUPPRESSION SHALL BE PROVIDED FOR THE POWER & CONTROL WIRING ASSOCIATED WITH THE INTERCOM, SLIDING GATES, EXTERIOR READER INTERFACE MODULES AND POWER SUPPLIES. REFER TO MPF SPECIFICATON SECTION 281304.
5. REFER TO DETAIL P1-2-4k FOR APPLICABLE SITE DIMENSIONS AND REQUIREMENTS.
6. CAMERA FINAL MOUNTING HEIGHTS SHALL BE CHOSEN TO SUIT THE APPLICATION.

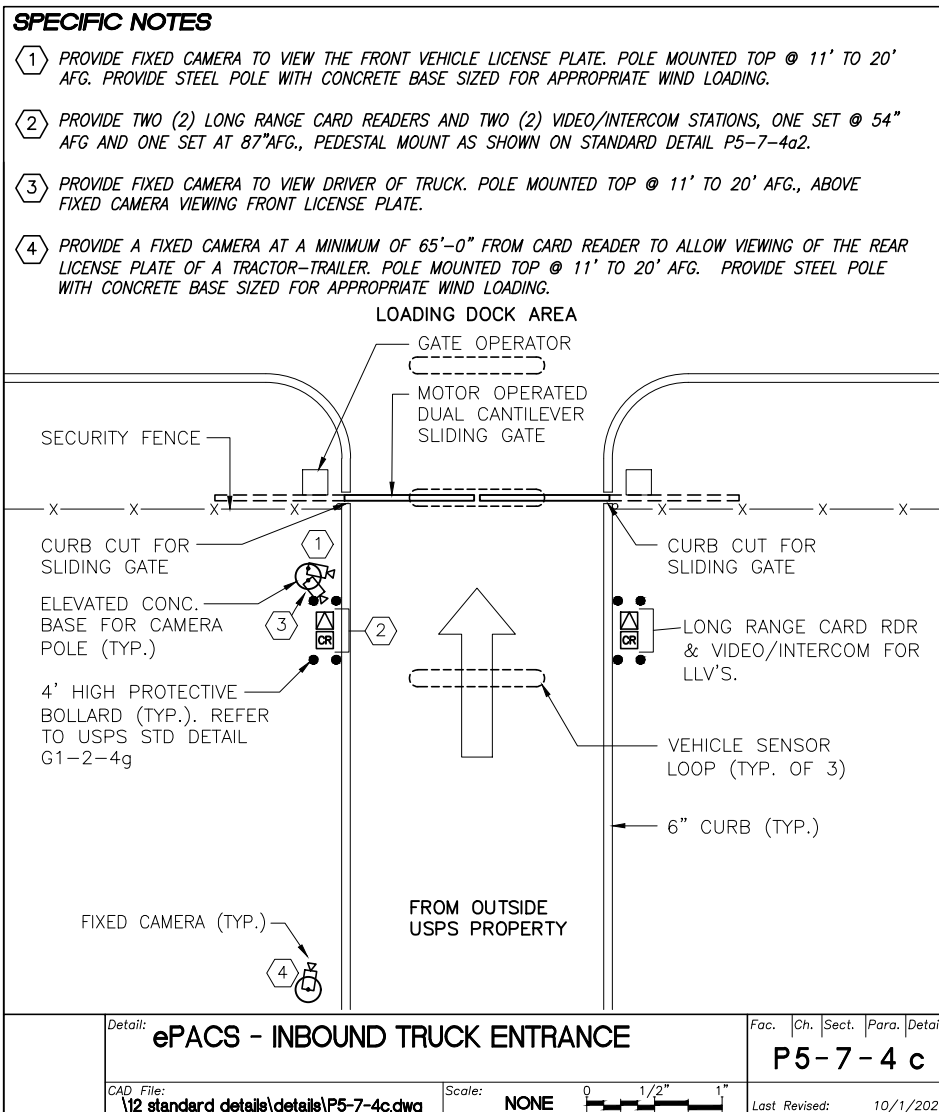

Detail:	ePACS - INBOUND TRUCK ENTRANCE	Fac.	Ch.	Sect.	Para.	Detail
						P5-7-4 c
CAD File:	\\12 standard details\details\P5-7-4c.dwg	Scale:	NONE	0 1/2" 1"		Last Revised: 10/1/2023



STANDARD DETAIL LIBRARY

NOTES TO A/E:

1. POLES SUPPORTING CAMERAS SHALL BE EQUIPPED WITH ELEVATED CONCRETE BASES TO PROTECT FROM VEHICULAR IMPACT. REFER TO DETAILS P5-7-2a THRU 2a8.
2. PROVIDE INDIVIDUAL SURGE PROTECTIVE DEVICES (POWER AND LOW VOLTAGE) AT BOTH ENDS OF ALL EXTERIOR COPPER ePACS WIRING AND ASSOCIATED WIRING EXITING THE BUILDING. SURGE SUPPRESSION SHALL BE PROVIDED FOR THE POWER & CONTROL WIRING ASSOCIATED WITH THE SLIDING GATES. REFER TO MPF SPECIFICATION SECTION 281304.
3. REFER TO DETAIL P1-2-4I FOR APPLICABLE SITE DIMENSIONS AND REQUIREMENTS.
4. CAMERA FINAL MOUNTING HEIGHTS SHALL BE CHOSEN TO SUIT THE APPLICATION.

SPECIFIC NOTES

- 1 PROVIDE FIXED CAMERA TO VIEW FRONT OF VEHICLE. POLE MOUNTED TOP @ 11' TO 20' AFG. PROVIDE STEEL POLE WITH CONCRETE BASE SIZED FOR APPROPRIATE WIND LOADING.
- 2 PROVIDE FIXED CAMERA TO VIEW REAR OF DEPARTING VEHICLE. POLE MOUNTED TOP @ 11' TO 20' AFG ABOVE FIXED CAMERA VIEWING FRONT OF VEHICLE

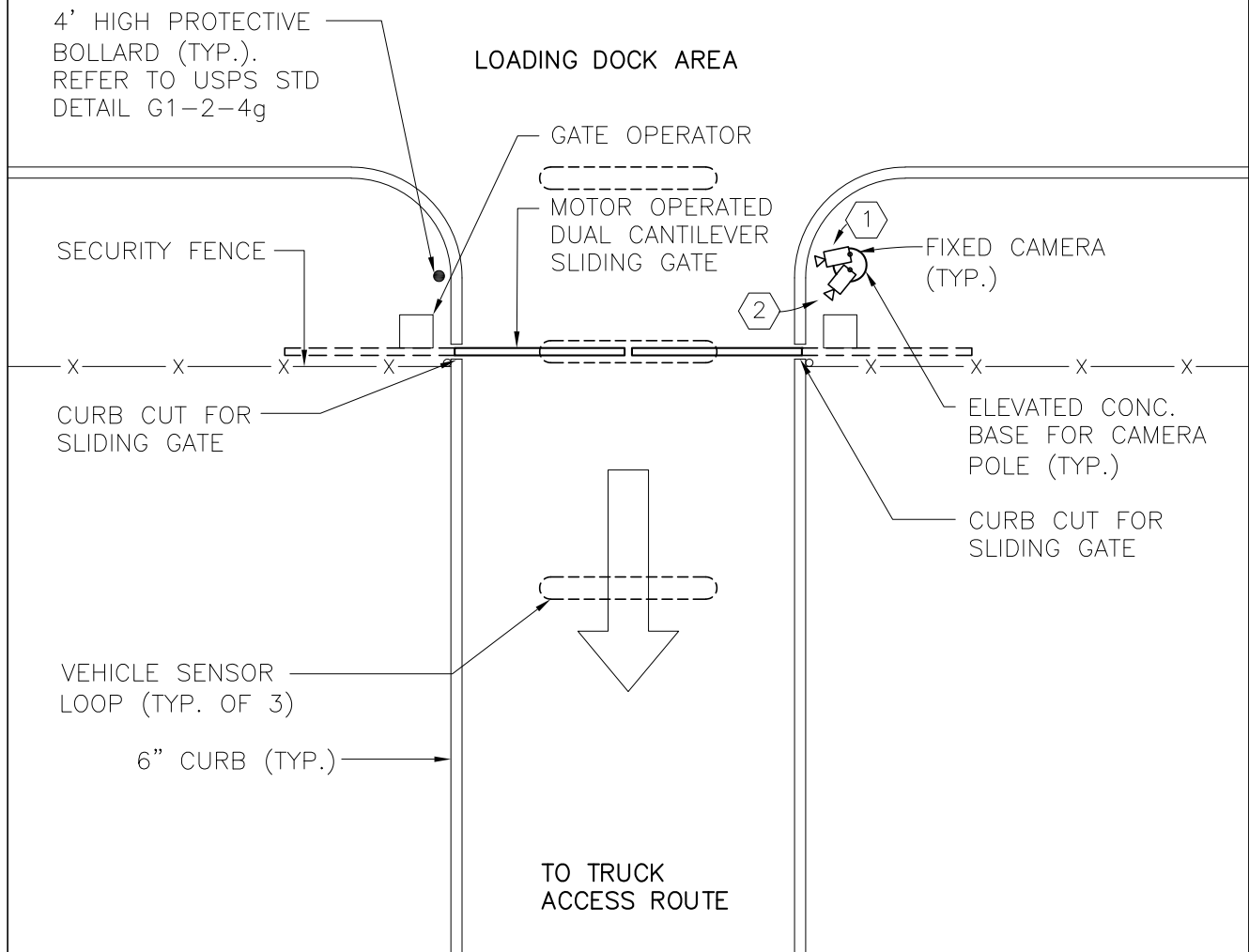

Detail: ePACS - OUTBOUND TRUCK EXIT		Fac.	Ch.	Sect.	Para.	Detail
		P5-7-4 d				
CAD File:	Scale:	0		1/2"	1"	Last Revised:
12 standard details\details\P5-7-4d.dwg	1/8"=1'-0"					7/2/2021

NOTES TO A/E:

1. PROVIDE LONG RANGE RDR. & INTERCOM ONLY AT FACILITIES WHERE LLV'S ARE OPERATED. ALL DEVICES MOUNTED AT 54" AFG., PEDESTAL MOUNT AS SHOWN ON STANDARD DETAIL P5-7-4a1.
2. POLES SUPPORTING CAMERAS SHALL BE EQUIPPED WITH ELEVATED TYPE CONCRETE BASES TO PROTECT FROM VEHICULAR IMPACT. REFER TO DETAILS P5-7-2a THRU 2a8.
3. STRATEGICALLY LOCATE PROTECTIVE BARRIER PIPE BOLLARD(S) TO PROTECT CARD RDR & INTERCOM STATION FROM VEHICULAR TRAFFIC. THE A/E SHALL INCLUDE STANDARD PIPE BOLLARD DETAIL G1-2-4g1 WITH THE DESIGN DWGS..
4. PROVIDE INDIVIDUAL SURGE PROTECTIVE DEVICES (POWER AND LOW VOLTAGE) AT BOTH ENDS OF ALL EXTERIOR COPPER ePACS & INTERCOM WIRING AND ASSOCIATED WIRING EXITING THE BUILDING. SURGE SUPPRESSION SHALL BE PROVIDED FOR THE POWER & CONTROL WIRING ASSOCIATED WITH THE INTERCOM, SLIDING GATES, EXTERIOR READER INTERFACE MODULES AND POWER SUPPLIES. REFER TO MPF SPECIFICATION SECTION 281304.
5. REFER TO DETAIL P1-2-4n FOR APPLICABLE SITE DIMENSIONS AND REQUIREMENTS.
6. CAMERA FINAL MOUNTING HEIGHTS SHALL BE CHOSEN TO SUIT THE APPLICATION.

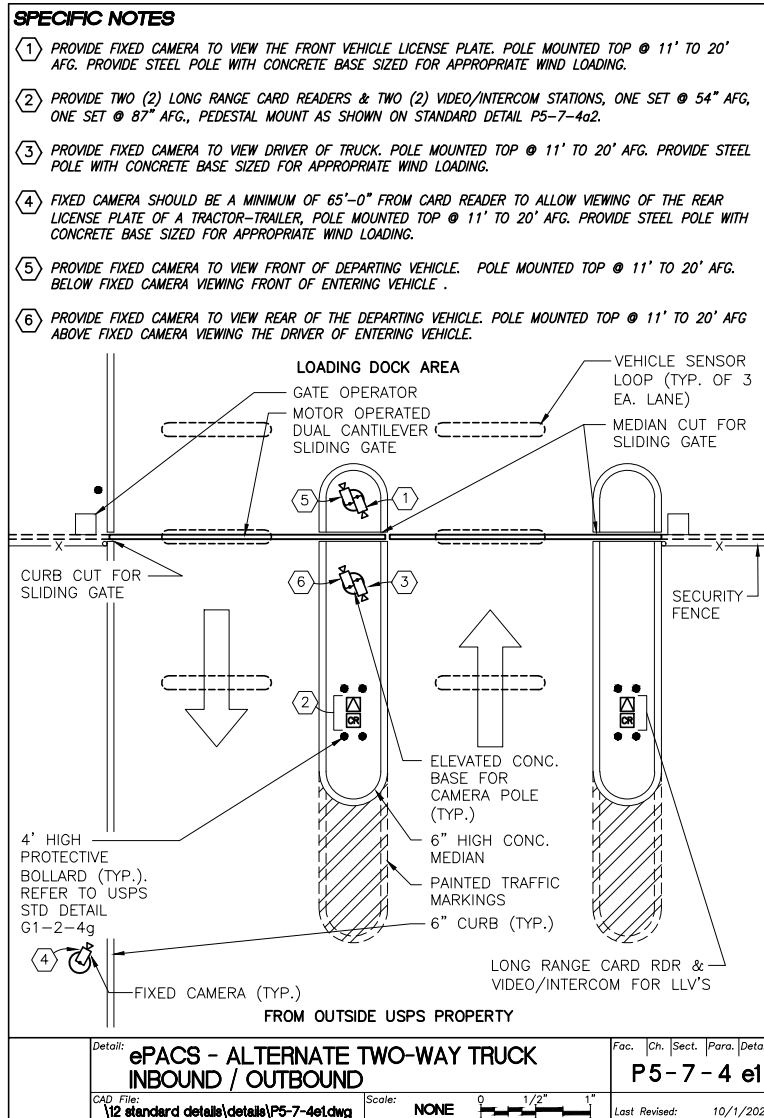

Detail:	ePACS - ALTERNATE TWO-WAY TRUCK INBOUND / OUTBOUND	Fac.	Ch.	Sect.	Para.	Detail
						P5-7-4 e1
CAD File:	\12 standard details\details\P5-7-4e1.dwg	Scale:	NONE	0 1/2" 1"		Last Revised: 10/1/2023



NOTES TO A/E:

1. POLES SUPPORTING CAMERAS SHALL BE EQUIPPED WITH ELEVATED CONCRETE BASES TO PROTECT FROM VEHICULAR IMPACT. REFER TO DETAILS P5-7-2a THRU 2a8.
2. ENTRANCES TO EMPLOYEE PARKING LOTS AT BASELINE SECURITY FACILITIES MUST HAVE A MOTORIZED BARRIER ARM LIFT GATE AND MANUAL SLIDING/SWING GATES. HIGH RISK LOCATIONS REQUIRE MOTORIZED SLIDING/SWING GATES, IN LIEU OF MANUAL GATES. THE BARRIER ARM LIFT GATE SHALL NOT BE PROVIDED. COORDINATE REQUIREMENTS WITH USPIS.
3. EXITS FROM EMPLOYEE PARKING LOTS AT BASELINE SECURITY FACILITIES MUST HAVE A MOTORIZED BARRIER ARM LIFT GATE AND MANUAL SLIDING/SWING GATES. HIGH RISK LOCATIONS REQUIRE MOTORIZED SLIDING/SWING GATES, IN LIEU OF MANUAL GATES. THE BARRIER ARM LIFT GATE SHALL NOT BE PROVIDED. COORDINATE REQUIREMENTS WITH USPIS.
4. STRATEGICALLY LOCATE PROTECTIVE BARRIER PIPE BOLLARD(S) TO PROTECT CARD RDR. & INTERCOM STATION FROM VEHICULAR TRAFFIC. THE A/E SHALL INCLUDE STANDARD PIPE BOLLARD DETAIL G1-2-4g WITH THE DESIGN DWGS..
5. PROVIDE INDIVIDUAL SURGE PROTECTIVE DEVICES (POWER AND LOW VOLTAGE) AT BOTH ENDS OF ALL EXTERIOR COPPER ePACS AND INTERCOM WIRING AND ASSOCIATED WIRING EXITING THE BUILDING. SURGE SUPPRESSION SHALL BE PROVIDED FOR THE POWER & CONTROL WIRING ASSOCIATED WITH THE INTERCOM, BARRIER ARM GATES, SLIDING GATES (IF MOTORIZED) EXTERIOR READER INTERFACE MODULES & POWER SUPPLIES. REFER TO MPF SPECIFICATION SECTION 281304.
6. REFER TO DETAIL P1-2-4j FOR APPLICABLE SITE DIMENSIONS AND REQUIREMENTS.
7. CAMERA FINAL MOUNTING HEIGHTS SHALL BE CHOSEN TO SUIT THE APPLICATION.

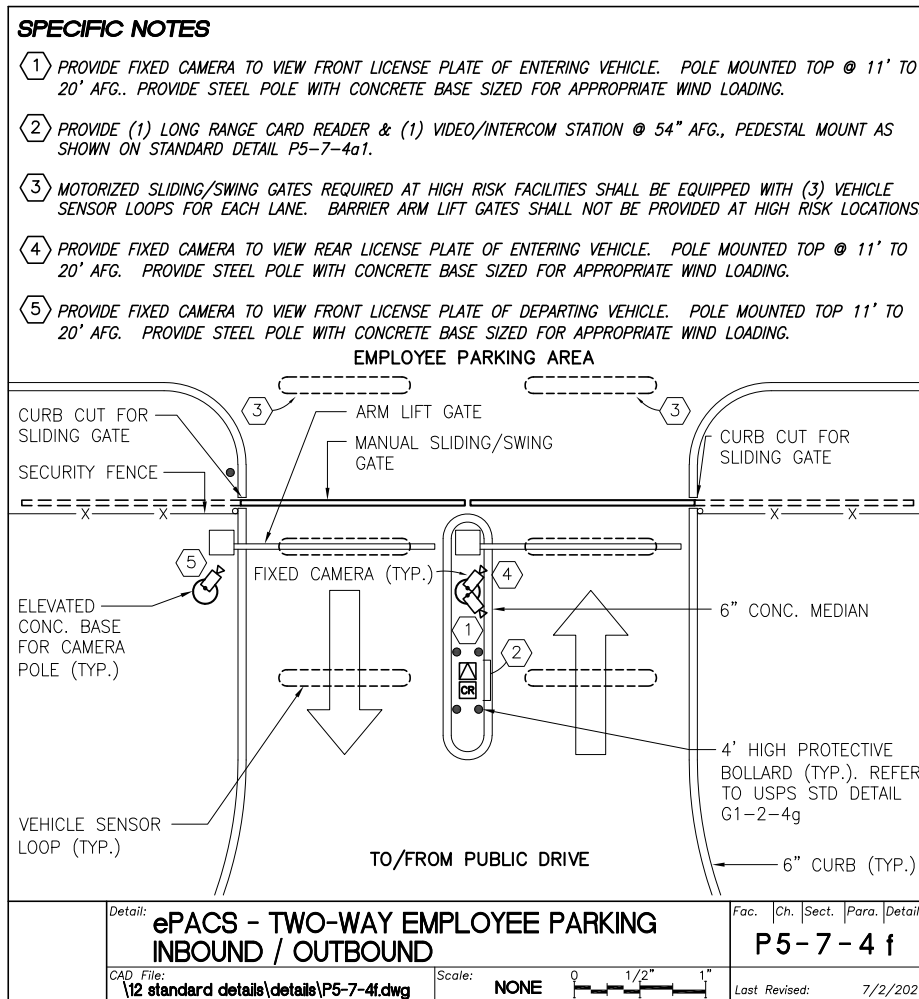

Detail: ePACS - TWO-WAY EMPLOYEE PARKING INBOUND / OUTBOUND					Fac. Ch. Sect. Para. Detail P5-7-4 f
CAD File: \\12 standard details\details\P5-7-4f.dwg		Scale: NONE	0 1/2" 1"		Last Revised: 7/2/2021



NOTES TO A/E:

1. PROVIDE PANIC HARDWARE AND DOOR ALARMS FOR EXIT DOORS AS INDICATED IN MPFDC 1 SECTION 2-7.2.2 AND MPFDC 1 SECTION 5-7.6.
2. ALL DOUBLE LEAFED DOORS (NEW OR EXIST'G.) SHALL BE PROVIDED WITH (2) MAG LOCKS. PROVIDE SURF. MTD. DOOR CONTACTS FOR EXIST'G. DOUBLE LEAF DOORS.
3. THIS DETAIL DEPICTS A DOUBLE LEAF DOOR CONFIGURATION. FOR SINGLE LEAF DOORS INCORPORATE THE FOLLOWING:
 - a. ELECTRIC STRIKES (ES) ARE THE PREFERRED METHOD OF CONTROLLING NEW DOORS.
 - b. EXIST'G. SINGLE LEAF DOORS NOT PRESENTLY EQUIPPED W/ELECTRIC STRIKES SHALL UTILIZE MAG LOCKS AND SURFACE MOUNTED DOOR CONTACTS.

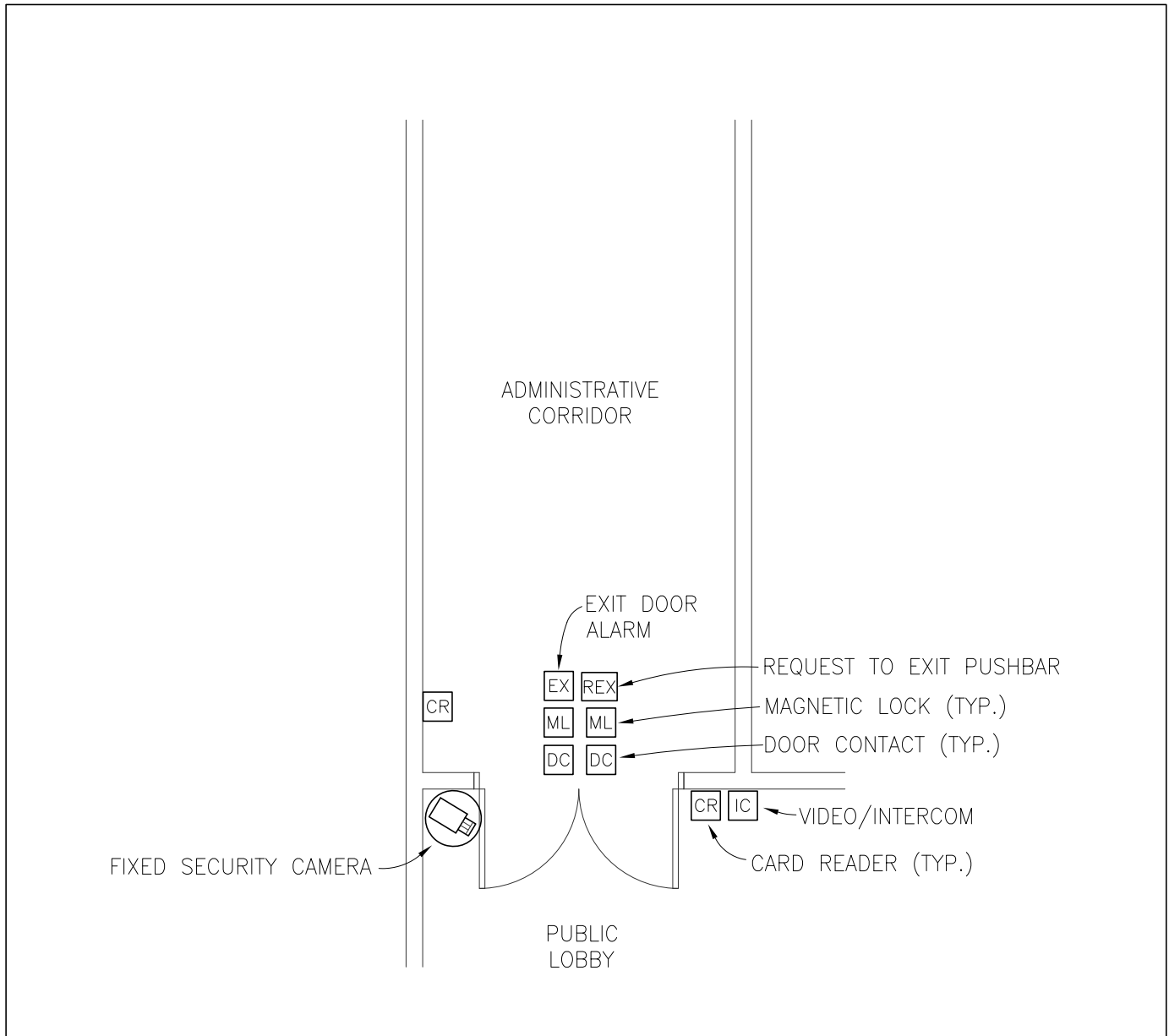

Detail: ePACS - MAIN ENTRANCE FROM PUBLIC LOBBY TO ADMIN.		Fac.	Ch.	Sect.	Para.	Detail
CAD File: 12 standard details\details\P5-7-4g.dwg		Scale: NONE				P5-7-4g Last Revised: 8/21/2019

NOTES TO A/E:

1. PROVIDE PANIC HARDWARE AND DOOR ALARMS FOR EXIT DOORS AS INDICATED IN MPFDC 1 SECTION 2-7.2.2 AND MPFDC 1 SECTION 5-7.6.
2. ELECTRIC STRIKES (ES) ARE THE PREFERRED METHOD OF CONTROLLING NEW SINGLE LEAF DOORS.
3. ALL DOUBLE LEAFED DOORS (NEW OR EXIST'G.) SHALL BE PROVIDED WITH (2) MAG LOCKS. PROVIDE SURF. MTD. DOOR CONTACTS FOR EXIST'G. DOUBLE LEAF DOORS.

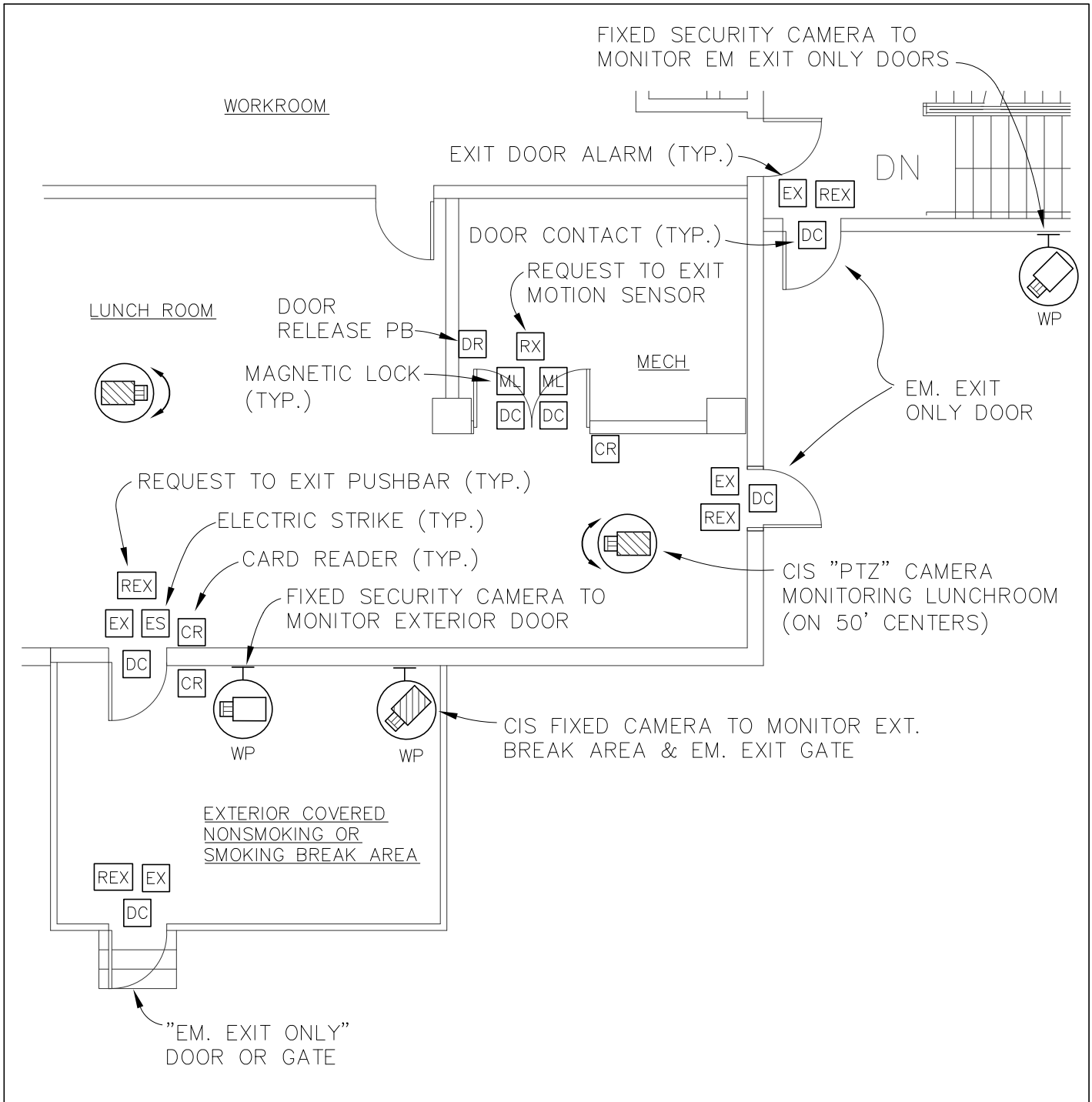

Detail:	ePACS - LUNCHROOM TO EXTERIOR BREAK AREA (NEW)				Fac.	Ch.	Sect.	Para.	Detail	
					P5-7-4 h					
CAD File:	\12 standard details\details\P5-7-4h.dwg			Scale:	1/8" = 1'-0"		0 1/2" 1"		Last Revised:	7/6/2020

NOTES TO A/E:

1. PROVIDE PANIC HARDWARE AND ALARMS FOR EXIT DOORS AS INDICATED IN MPFDC 1 SECTION 2-7.2.2 AND MPFDC 1 SECTION 5-7.6.
2. EXISTING SINGLE LEAF DOORS NOT PRESENTLY EQUIPPED W/ELECTRIC STRIKES SHALL UTILIZE ELECTROMAGNETIC (ML) STYLE LOCKS AS SHOWN.

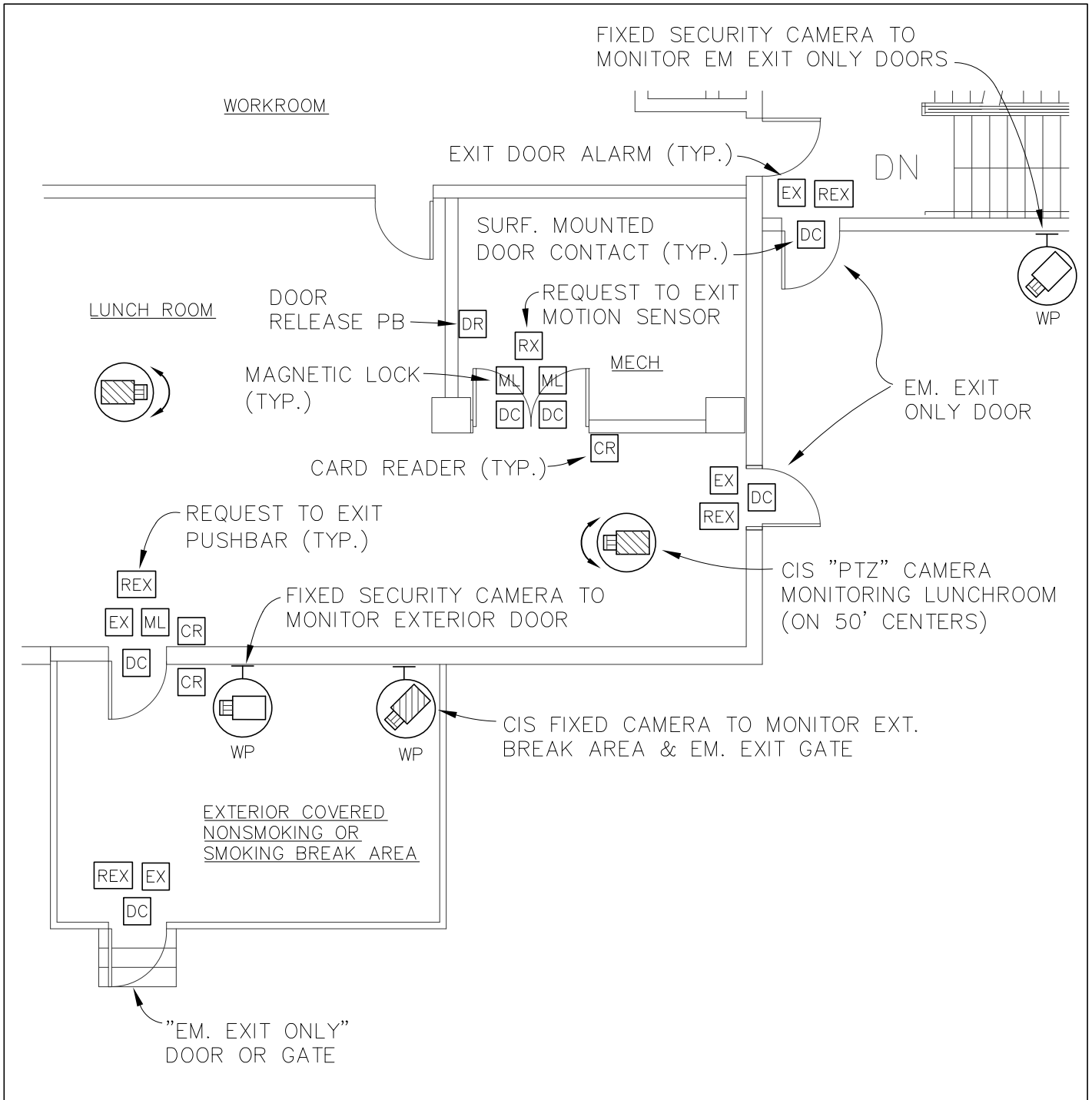

Detail:	ePACS - LUNCHROOM TO EXTERIOR BREAK AREA (EXISTING)	Fac.	Ch.	Sect.	Para.	Detail
						P5-7-4 h1
CAD File:	Scale:	0 1/2" 1"			Last Revised:	7/6/2020
\12 standard details\details\P5-7-4h1.dwg		1/8" = 1'-0"				

NOTES TO A/E:

1. PROVIDE PANIC HARDWARE AND DOOR ALARMS FOR EXIT DOORS AS INDICATED IN MPFDC 1 SECTION 2-7.2.2 AND MPFDC 1 SECTION 5-7.6.
2. ALL DOUBLE LEAFED DOORS (NEW OR EXIST'G.) SHALL BE PROVIDED WITH (2) MAG LOCKS. PROVIDE SURF. MTD. DOOR CONTACTS FOR EXIST'G. DOUBLE LEAF DOORS.
3. THIS DETAIL DEPICTS A DOUBLE LEAF DOOR CONFIGURATION. FOR SINGLE LEAF DOORS INCORPORATE THE FOLLOWING:
 - a. ELECTRIC STRIKES (ES) ARE THE PREFERRED METHOD OF CONTROLLING NEW DOORS.
 - b. EXIST'G. SINGLE LEAF DOORS NOT PRESENTLY EQUIPPED W/ELECTRIC STRIKES SHALL UTILIZE MAG LOCKS AND SURFACE MOUNTED DOOR CONTACTS.

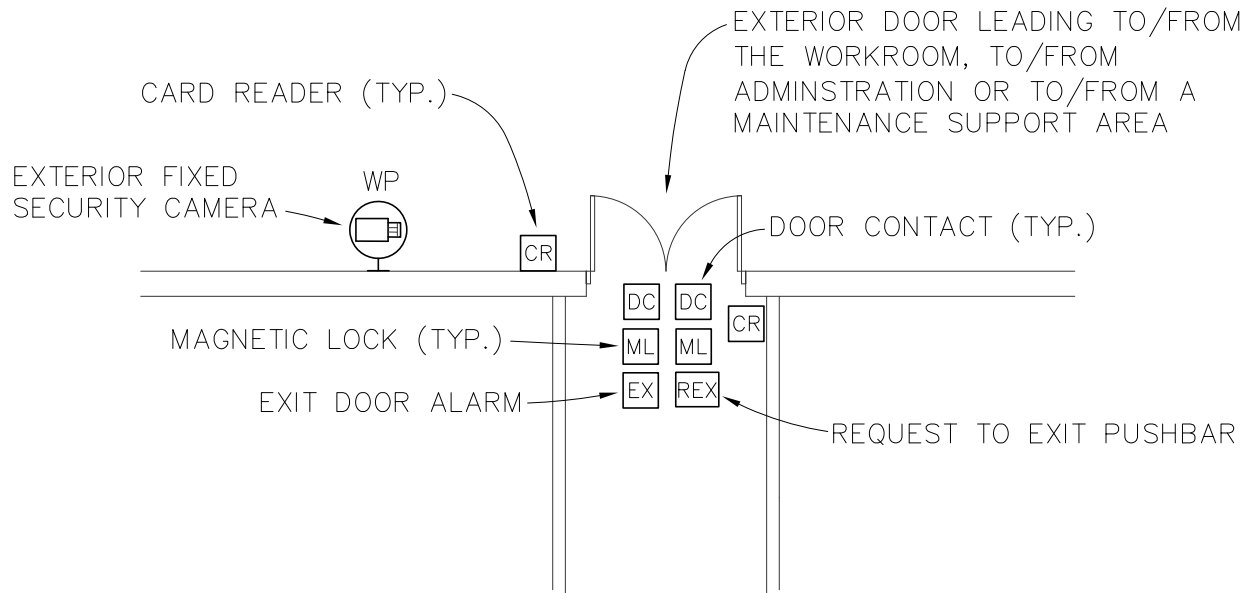

Detail:	ePACS - EXTERIOR ENTRY/EXIT DOOR	Fac.	Ch.	Sect.	Para.	Detail
						P5-7-4 i
CAD File:	\12 standard details\details\P5-7-4i.dwg	Scale:	1/8" = 1'-0"			Last Revised:
						8/21/2019



STANDARD DETAIL LIBRARY

NOTES TO A/E:

1. PROVIDE PANIC HARDWARE AND DOOR ALARMS FOR EXIT DOORS AS INDICATED IN MPFDC 1 SECTION 2-7.2.2 AND MPFDC 1 SECTION 5-7.6.
2. ALL DOUBLE LEAFED DOORS (NEW OR EXIST'G.) SHALL BE PROVIDED WITH (2) MAG LOCKS. PROVIDE SURF. MTD. DOOR CONTACTS FOR EXIST'G. DOUBLE LEAF DOORS.
3. THIS DETAIL DEPICTS A DOUBLE LEAF DOOR CONFIGURATION. FOR SINGLE LEAF DOORS INCORPORATE THE FOLLOWING:
 - a. ELECTRIC STRIKES (ES) ARE THE PREFERRED METHOD OF CONTROLLING NEW DOORS.
 - b. EXIST'G. SINGLE LEAF DOORS NOT PRESENTLY EQUIPPED W/ELECTRIC STRIKES SHALL UTILIZE MAG LOCKS AND SURFACE MOUNTED DOOR CONTACTS.

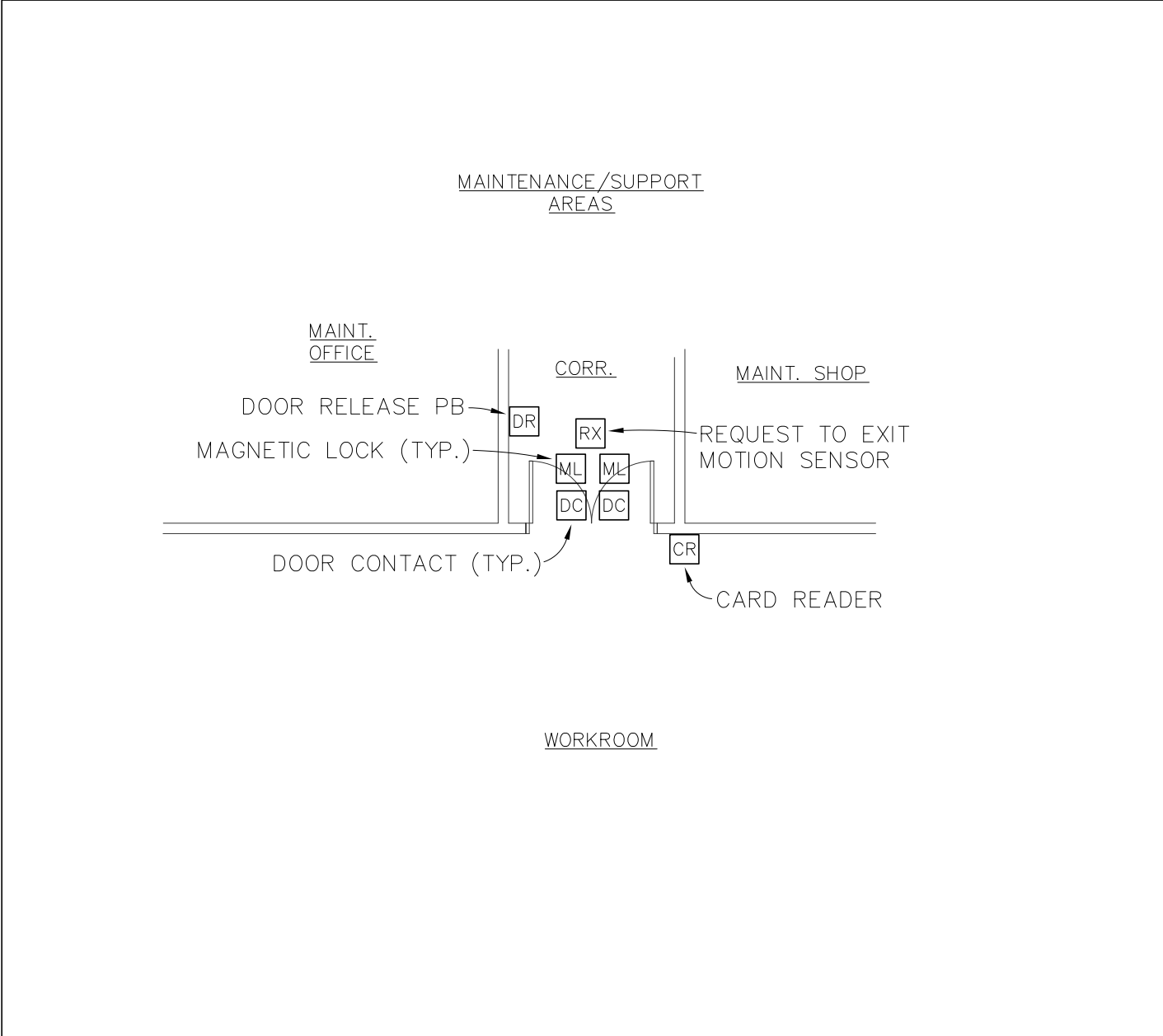

Detail: ePACS - INTERIOR DOORS FROM WORKROOM TO MAINTENANCE		Fac.	Ch.	Sect.	Para.	Detail
		P5-7-4j				
CAD File: 12 standard details\details\P5-7-4j.dwg		Scale: 1/8" = 1'-0"				Last Revised: 8/21/2019

NOTES TO A/E:

1. PROVIDE PANIC HARDWARE AND DOOR ALARMS FOR EXIT DOORS AS INDICATED IN MPFDC 1 SECTION 2-7.2.2 AND MPFDC 1 SECTION 5-7.6.
2. ALL DOUBLE LEAFED DOORS (NEW OR EXIST'G.) SHALL BE PROVIDED WITH (2) MAG LOCKS. PROVIDE SURF. MTD. DOOR CONTACTS FOR EXIST'G. DOUBLE LEAF DOORS.
3. THIS DETAIL DEPICTS A DOUBLE LEAF DOOR CONFIGURATION. FOR SINGLE LEAF DOORS INCORPORATE THE FOLLOWING:
 - a. ELECTRIC STRIKES (ES) ARE THE PREFERRED METHOD OF CONTROLLING NEW DOORS.
 - b. EXIST'G. SINGLE LEAF DOORS NOT PRESENTLY EQUIPPED W/ELECTRIC STRIKES SHALL UTILIZE MAG LOCKS AND SURFACE MOUNTED DOOR CONTACTS.
4. THE FIXED INVESTIGATIVE CAMERA VIEWING THE ENTRY DOORS SHALL BE WALL OR CEILING MOUNTED AS DETERMINED BY THE A/E.

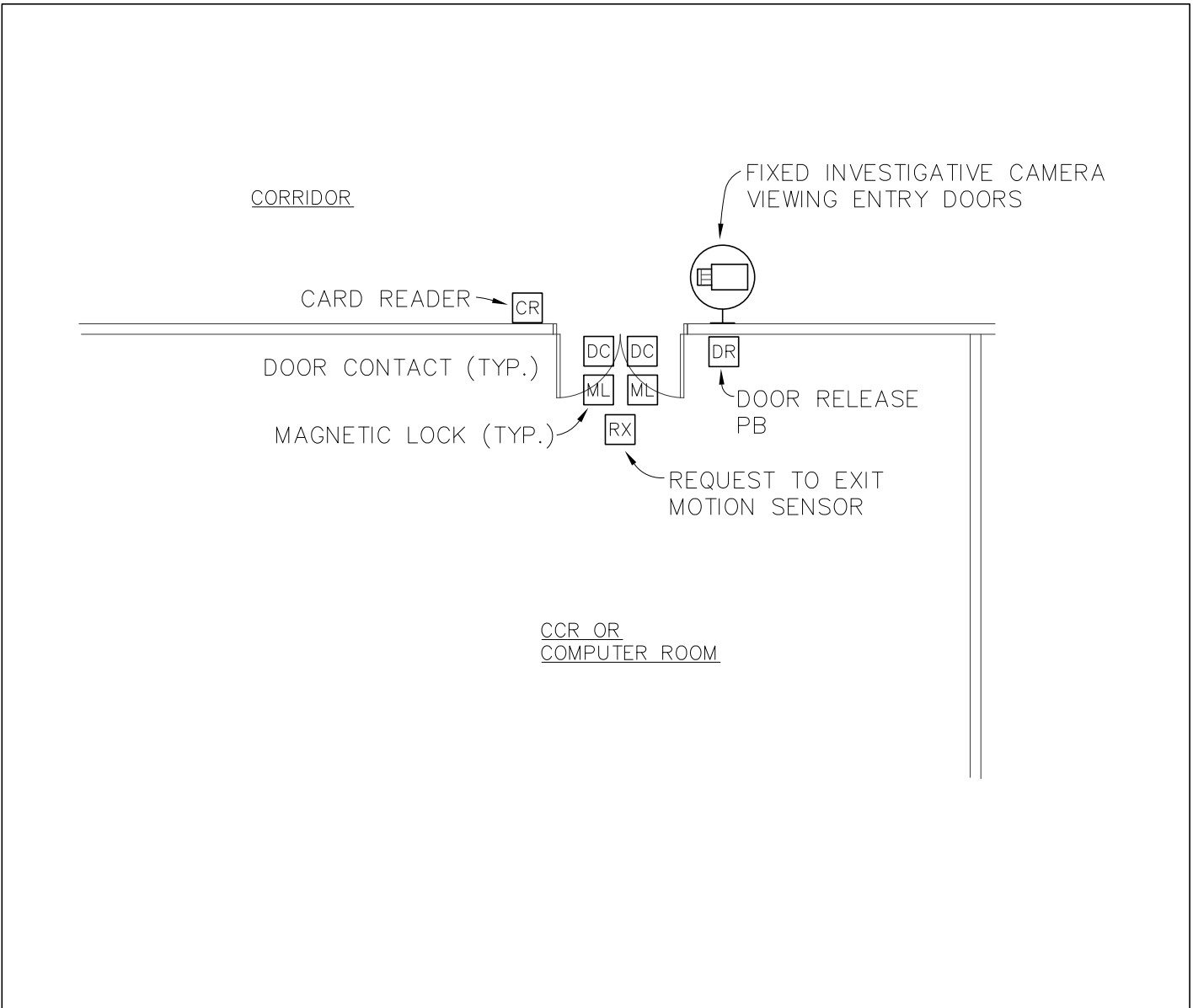

Detail: ePACS - CCR OR COMPUTER ROOM	Fac. Ch. Sect. Para. Detail P5-7-4k
	CAD File: \12 standard details\details\P5-7-4k.dwg Scale: 1/8" = 1'-0" 0 1/2" 1" Last Revised: 5/20/2020

NOTES TO A/E:

1. PROVIDE PANIC HARDWARE AND DOOR ALARMS FOR EXIT DOORS AS INDICATED IN MPFDC 1 SECTION 2-7.2.2 AND MPFDC 1 SECTION 5-7.6.
2. ALL DOUBLE LEAFED DOORS (NEW OR EXIST'G.) SHALL BE PROVIDED WITH (2) MAG LOCKS. PROVIDE SURF. MTD. DOOR CONTACTS FOR EXIST'G. DOUBLE LEAF DOORS.
3. THIS DETAIL DEPICTS A DOUBLE LEAF DOOR CONFIGURATION. FOR SINGLE LEAF DOORS INCORPORATE THE FOLLOWING:
 - a. ELECTRIC STRIKES (ES) ARE THE PREFERRED METHOD OF CONTROLLING NEW DOORS.
 - b. EXIST'G. SINGLE LEAF DOORS NOT PRESENTLY EQUIPPED W/ELECTRIC STRIKES SHALL UTILIZE MAG LOCKS AND SURFACE MOUNTED DOOR CONTACTS.

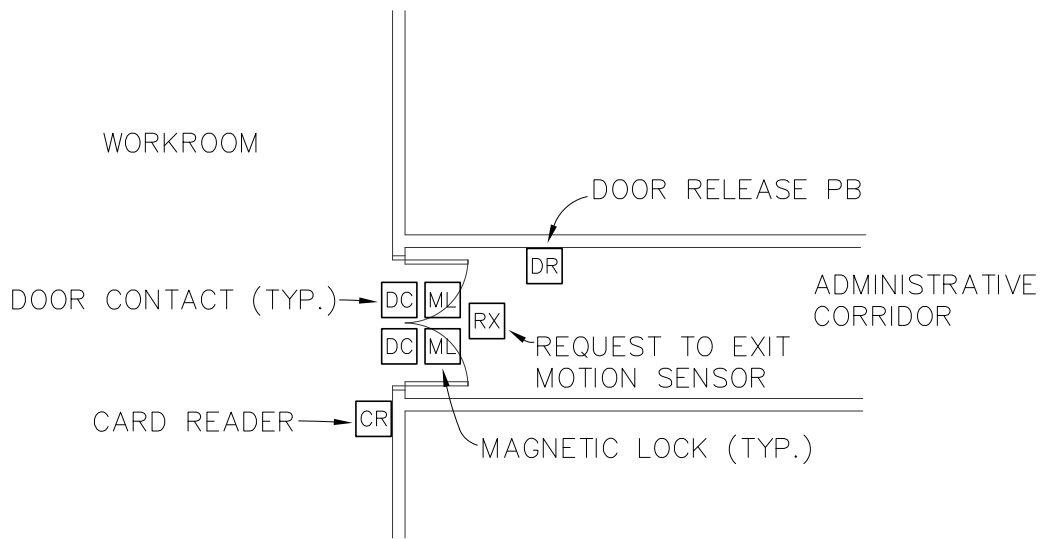

Detail: ePACS - INTERIOR ADMINISTRATIVE CORRIDOR	Fac. Ch. Sect. Para. Detail P5-7-41
	CAD File: \12 standard details\details\P5-7-41.dwg Scale: 1/8" = 1'-0" 0 1/2" 1" Last Revised: 8/21/2019

© Copyright 1997-2015 United States Postal Service

NOTES TO A/E:

- COORDINATE LOCATION OF SLIDING GATE, WINDOW AND SWINGING DOOR WITH USPS. INCLUDE LOCKING HARDWARE AND SECURITY PLATES TO PREVENT ACCESSING INTERIOR LOCK CONTROL AND DOOR RELEASE PUSHBUTTON FROM OUTSIDE OF CAGE.
- PROVIDE ENCLOSED LED LUMINAIRE, SURFACE MOUNTED BELOW WIRE MESH CEILING. MAINTAIN 50 FOOTCANDLES AT 30" ABOVE FINISHED FLOOR.
- PROVIDE 120 VAC OUTLETS AT 10'-0" ON CENTER AROUND PERIMETER.
- PLAN LOCATION AND DIMENSIONS "X" AND "Y" TO BE COORDINATED WITH 929 AND APPROVED BY USPS.
- WORKROOM PTZ CAMERAS THAT ARE IN CLOSE PROXIMITY TO VIEW THE SWINGING ENTRY/EGRESS DOOR/GATE, THE SLIDING SERVICE GATE AND/OR THE SLIDING SERVICE WINDOW MAY BE UTILIZED. THEREFORE, SEPARATE FIXED CAMERAS MAY NOT BE REQUIRED.
- REFER TO DETAILS (P2-2-2a & 2a1) FOR ARCHITECTURAL INFORMATION.
- THE SLIDING SERVICE WINDOW OR OTHER SIMILAR OPENINGS MUST BE EQUIPPED WITH A SELF-LOCKING SLIDING MESH PANEL. PROVIDE 120V., HARDWIRED, TIMED-BYPASS ALARM TO ACTIVATE IF THE MESH PANEL OF THE SLIDING SERVICE WINDOW IS LEFT OPEN FOR MORE THAN 30 MINUTES. BASIS OF DESIGN: (SUBSTITUTIONS PERMITTED) DETEX #EAX-3500 COMPLETE WITH ADJUSTABLE TIMED-BYPASS ALARM, RECHARGEABLE BATTERY, MAG. SWITCH & PLUG-IN 24 VAC XFMR.. THE TIMED-BYPASS ALARM IS REQUIRED REGARDLESS OF THE PRESENCE OF AN ePACS.

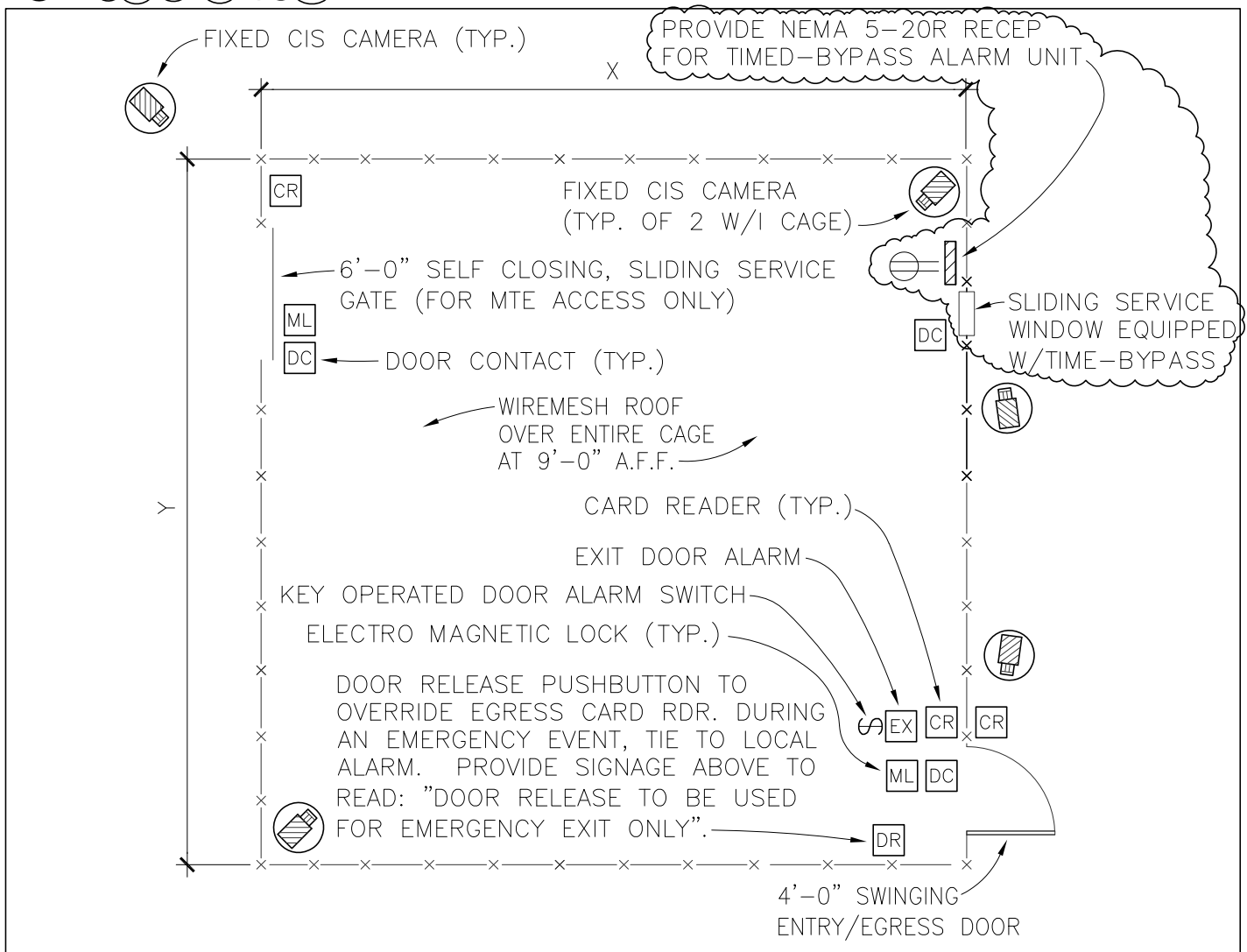

Detail:	ePACS - REGISTRY CAGE LAYOUT				Fac.	Ch.	Sect.	Para.	Detail
					P5-7-4 n				
CAD File:	Scale:		0 1/2" 1"		Last Revised: 9/8/2022				
\12 standard details\details\P5-7-4n.dwg			1/8" = 1'-0"						

NOTES TO A/E:

1. PROVIDE SECURITY CEILING AS REQUIRED BY HANDBOOK RE-5.
2. IF TURNSTILES ARE USED FOR EGRESS, THEN A/E IS TO PROVIDE DESIGN TO COMPLY WITH THE NFPA & LOCAL BUILDING CODES. NOTE THAT THE INBOUND ENTRY DIRECTION SHALL REMAIN SECURE.
3. PER NFPA 101, 7.2.1.6.2 THE EVACUATION PUSHBUTTON MUST BE LOCATED WITHIN 5 FT. OF NEAREST TURNSTILE OR THE RE-4 ACCESS GATE.

SPECIFIC NOTES

- 1 PROVIDE (1) FIXED CAMERA PER EVERY (2) TURNSTILES/DOORS; LOCATED TO VIEW ENTRY AND EXIT, TOTAL (2) CAMERAS.
- 2 PROVIDE (1) FIXED CAMERA TO MONITOR THE RE-4 GATE; LOCATED TO VIEW ENTRY AND EXIT, TOTAL (2) CAMERAS.
- 3 PROVIDE ADD'L. FIXED CAMERA TO VIEW OPERATION OF THE EVACUATION PUSHBUTTON. NO ADD'L. CAMERA IS NEEDED, UNLESS THE CAMERAS MONITORING THE TURNSTILES OR RE-4 GATE DO NOT VIEW THE PUSHBUTTON.

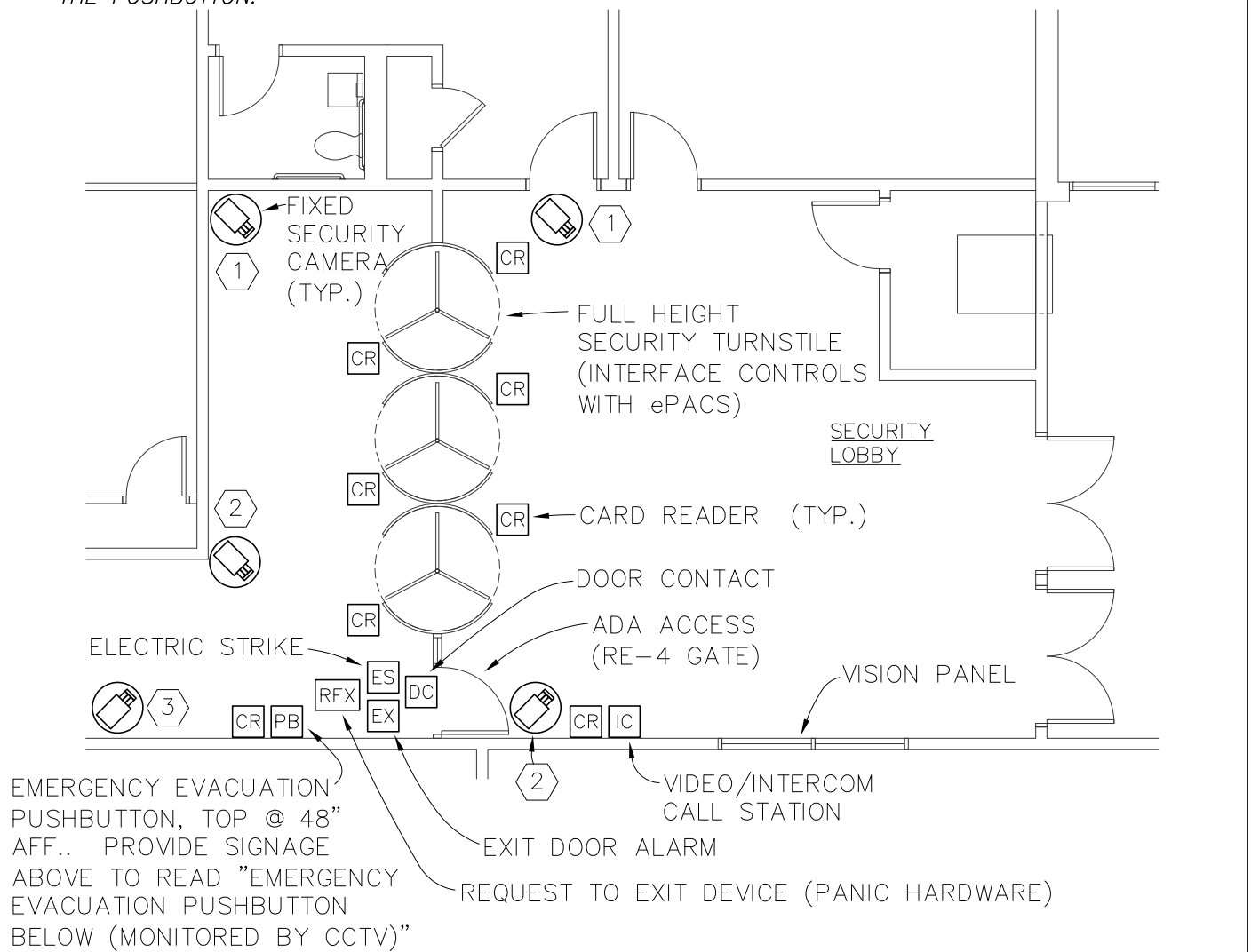

Detail: ePACS - FULL HEIGHT SECURITY LOBBY TURNSTILES	Fac. Ch. Sect. Para. Detail P5-7-4 p
	CAD File: 12 standard details\details\P5-7-4p.dwg Scale: 1/8" = 1'-0" Last Revised: 8/21/2019

NOTES TO A/E:

- ELECTRIC STRIKES (ES) ARE THE PREFERRED METHOD FOR CONTROLLING NEW SINGLE LEAF DOORS. ELECTRO-MAGNETIC (ML) STYLE LOCKS SHALL BE UTILIZED ON ALL DOUBLE LEAF DOORS (NEW OR EXIST'G.). NEW SINGLE LEAF DOORS EQUIPPED WITH SINGLE CARD READER FOR ENTRY SHALL HAVE DOOR HARDWARE SUITED FOR "FREE EXIT". DOOR SHALL ALSO BE EQUIPPED WITH A MOTION SENSOR (RX) TO DISABLE THE DOOR CONTACT DURING "FREE" EGRESS. PROVIDE PANIC PUSHBARS (REX) AND EXIT DOOR ALARMS (EX) WHERE REQUIRED.
- EXISTING SINGLE LEAF DOORS NOT PRESENTLY EQUIPPED WITH ELECTRIC STRIKES SHALL UTILIZE ELECTRO-MAGNETIC (ML) STYLE LOCKS. EXISTING INTERIOR DOORS EQUIPPED WITH SINGLE CARD READER FOR ENTRY AND ML STYLE LOCKS SHALL BE PROVIDED WITH MOTION SENSOR (RX) CONTROL AND DOOR RELEASE PUSHBUTTON ON THE EGRESS SIDE OF THE DOOR. EXISTING EXTERIOR EGRESS DOORS EQUIPPED WITH IN/OUT CARD READERS SHALL BE PROVIDED WITH PANIC PUSHBARS (REX) ON THE EGRESS SIDE OF THE DOOR. PROVIDE EXIT DOOR ALARM (EX) WHERE REQUIRED.
- MAGNETIC STYLE DOOR SWITCH CONTACTS ARE THE PREFERRED METHOD FOR SUPERVISING THE DOOR POSITION (OPEN OR CLOSED). HINGED TRANSFER DEVICES SHALL NOT BE UTILIZED. ALL ePACS COMPONENTS TO INCLUDE DOOR CONTACTS AND ELECTRIC STRIKES SHALL BE PROVIDED BY THE LOW VOLTAGE SUBCONTRACTOR. REQUEST TO EXIT PUSHBAR SHALL BE PROVIDED BY THE DOOR HARDWARE SUPPLIER.
- REFER TO DETAILS P5-7-4r THRU P5-7-4r3 FOR TYPICAL DOOR CONFIGURATIONS.
- THE MAJORITY OF THE ePACS WIRING WILL BE INSTALLED ABOVE CEILINGS WITHOUT CONDUIT. ALL ePACS CABLING USED THROUGHOUT THIS PROJECT SHALL COMPLY WITH THE REQUIREMENTS AS OUTLINED IN THE NATIONAL ELECTRIC CODE (NEC) ARTICLE 725. ALL CABLING SHALL BARE CMP AND OR APPROPRIATE MAKINGS FOR THE ENVIRONMENT WHICH THEY ARE INSTALLED.
- CABLING Routed UNDERGROUND OR EXTERIOR OF THE BLDG. OR THROUGH INACCESSIBLE CEILINGS OR LESS THAN 10FT.-0 IN. AFF. IN THE WORKROOM, PLATFORM OR MECHANICAL MEZZANINES SHALL BE CONTAINED IN CONDUIT. PROVIDE FLUSH BOXES WITHIN FINISHED AREAS AND FACTORY SURFACE BOXES IN UNFINISHED AREAS. PROVIDE 3/4 INCH CONDUIT RISERS WITH 90 DEGREE BEND AND BUSHING FOR ALL WALL MOUNTED DEVICES.

ePACS CONTROL DEVICE SCHEDULE											
1ST FLOOR											NOTES
DOOR #	EGRESS REQUIRED	EGRESS SIGN	CARD READER ENTRY	CARD READER EXIT	DOOR CONTACT	EXIT ALARM	MAG LOCK	ELECT STRIKE	EMERGENCY EXIT BY MOTION SENSOR	EMERGENCY EXIT BY PUSH BAR	
1	*	*	*	*	*	*	-	*	-	*	EXTERIOR DOOR TO EXTERIOR BREAK AREA (CARD RDR. ENTRY/EXIT)
2	-	-	-	-	*	-	-	-	-	-	EXTERIOR OVERHEAD COILING DOOR
3	*	*	*	*	*	*	*	-	-	*	EXTERIOR DOOR FOR CONTRACT DRIVER (CARD RDR. ENTRY/EXIT, VIDEO INTERCOM)
4	-	-	*	-	*	-	-	-	*	-	INTERIOR DOOR (CARD RDR. ENTRY; FREE EXIT)
5	-	-	2	-	HSRD CONTROLS						MAIL VESTIBULE: HSRD INTO WORKROOM (CARD RDR & HANGING LRCR)
6	-	-	-	2	HSRD CONTROLS						MAIL VESTIBULE: HSRD FROM WORKROOM (CARD RDR & HANGING LRCR)
7	*	*	*	*	*	*	-	-	-	*	MAIL VESTIBULE: PERSONNEL DOOR (CARD RDR ENTRY/EXIT)
8	*	*	-	-	*	*	-	-	-	*	EMERGENCY EXIT ONLY DOOR FROM WORKROOM
9	*	*	*	*	*	*	-	-	-	*	RE-4 DOOR @ EMPLOYEE ENTRY LOBBY (CARD RDR. ENTRY/EXIT, VIDEO INTERCOM & EVAC. P.B.)
10	-	-	*	*	TURNSTILE CONTROLS						TURNSTILE @ EMPLOYEE ENTRY LOBBY (CARD RDR. ENTRY/EXIT & EVAC. PUSHBUTTON)
11	*	-	*	-	*	-	-	*	*	-	INTERIOR PERSONNEL DOOR - WORKROOM INTO MAINTENANCE (CARD RDR. ENTRY; FREE EXIT)
12	*	*	*	*	*	*	-	-	-	*	EXTERIOR DOOR INTO MAINTENANCE AREA (CARD RDR. ENTRY/EXIT)
13	-	-	-	-	*	-	-	-	-	-	EXTERIOR ROLL-UP DOOR INTO PARTS STORAGE
14	-	-	*	*	*	*	*	-	-	-	REGISTRY CAGE PERSONNEL DOOR (CARD RDR. ENTRY/EXIT, DOOR RELEASE P.B.)
15	-	-	*	-	*	-	*	-	-	-	REGISTRY CAGE SLIDING GATE (FOR MTE ACCESS)
16	*	-	*	-	2	-	2	-	*	-	INTERIOR DOUBLE DOORS INTO COMPUTER ROOM (CARD RDR. ENTRY, DOOR RELEASE P.B.)
17	-	-	*	-	2	-	2	-	*	-	INTERIOR DOUBLE DOOR - WORKROOM INTO ADMIN. (CARD RDR. ON WORKRM SIDE, DOOR RELEASE P.B.)
18	*	*	*	*	2	*	2	-	-	*	MAIN ENTRANCE FROM PUBLIC LOBBY INTO ADMIN. AREA (CARD RDR. ENTRY/EXIT, VIDEO INTERCOM)

KEY:
 * REQUIRED
 - NOT REQUIRED
 2 (2) DEVICES REQUIRED

NOTES:
 1. REFER TO DETAILS P5-7-4q1 & P5-7-4q2 FOR APPLICABLE ePACS RISER DIAGRAMS.
 2. REFER TO DETAIL P5-7-4q3 FOR ePACS WIRING SCHEDULE.

Detail: ePACS CONTROL DEVICE SCHEDULE	Fac. Ch. Sect. Para. Detail
CAD File: ..\usps\library\details\P5-7-4q.dwg	Scale: NTS 0 1/2" 1"
	Last Revised: 8/30/2021

Detail: ePACS CONTROL DEVICE SCHEDULE	Fac. Ch. Sect. Para. Detail
	P5-7-4q
CAD File: ..\usps\library\details\P5-7-4q.dwg	Scale: NTS 0 1/2" 1"
	Last Revised: 8/30/2021



NOTES TO A/E:

- EACH (16) READER CONTROLLER SHALL BE WIRED FOR A MAXIMUM OF (13) CARD READERS; (3) SPARE POSITIONS SHALL REMAIN FOR FUTURE USE.
- EACH (8) CIRCUIT POWER SUPPLY SHALL BE WIRED FOR A MAXIMUM COMBINATION OF (6) MAG. LOCKS, EXIT DOOR ALARMS OR ELECTRIC STRIKES; (2) SPARE CIRCUITS SHALL REMAIN FOR FUTURE.
- REFER TO TYPICAL VIDEO INTERCOM RISER DIAGRAM DETAIL P5-7-4q4 FOR ADD'L GATE RELEASE WIRING. GATE RELEASE WIRING CONTROLLED FROM THE VIDEO INTERCOM DOOR CALL-IN STATIONS SHALL BE INDEPENDENT OF THE ePACS.
- THE POWER SUPPLIES @ THE CONTROLLERS & LRCR'S REQUIRE 120V. POWER.
- REFER TO STANDARD DETAILS P5-7-4a3 & 4a4 FOR TYPICAL ePACS TERMINAL CABINET DETAILS.
- THIS RISER DIAGRAM IS INTENDED TO BE USED AS A GUIDE TO THE PROJECT ENGR.. THE RISER DIAGRAM SHALL BE MODIFIED TO SUITE SPECIFIC PROJECT REQUIREMENTS; QUANTITIES OF CARD RDRS., "RIM'S", CONTROLLER'S AND POWER SUPPLIES ARE PROJECT SPECIFIC.

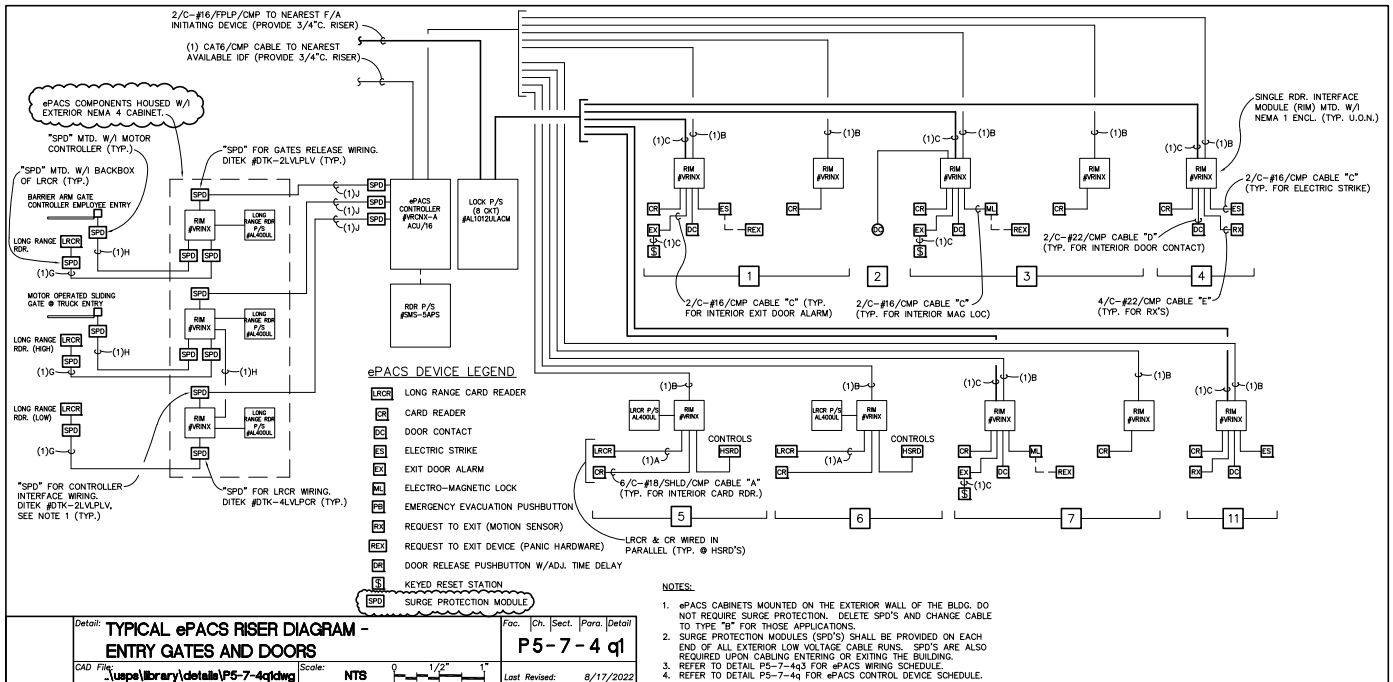

© Copyright 1997-2015 United States Postal Service

Detail: TYPICAL ePACS RISER DIAGRAM - ENTRY GATES AND DOORS		Fac.	Ch.	Sec.	Para.	Detail
		P5-7-4 q1				
CAD File:	Scale:	0 1/2" 1"		Last Revised: 8/17/2022		
..\\usps\library\details\P5-7-4q1dwg	NTS					



STANDARD DETAIL LIBRARY

NOTES TO A/E:

1. EACH (16) READER CONTROLLER SHALL BE WIRED FOR A MAXIMUM OF (13) CARD READERS; (3) SPARE POSITIONS SHALL REMAIN FOR FUTURE USE.
2. EACH (8) CIRCUIT POWER SUPPLY SHALL BE WIRED FOR A MAXIMUM COMBINATION OF (6) MAG. LOCKS, EXIT DOOR ALARMS OR ELECTRIC STRIKES; (2) SPARE CIRCUITS SHALL REMAIN FOR FUTURE.
3. EMERGENCY EVACUATION P.B. SHALL BE INTERFACED WITH THE EXIT TURNSTILE & RE-4 PERSONNEL DOOR. ACTIVATION SHALL CAUSE AUDIBLE ALARM AND FREE EXIT. INBOUND ENTRY DIRECTION SHALL REMAIN SECURE.
4. THIS RISER DIAGRAM IS INTENDED TO BE USED AS A GUIDE TO THE PROJECT ENGR.. THE RISER DIAGRAM SHALL BE MODIFIED TO SUITE SPECIFIC PROJECT REQUIREMENTS; QUANTITIES OF CARD RDRS., "RIM'S", CONTROLLER'S AND POWER SUPPLIES ARE PROJECT SPECIFIC.

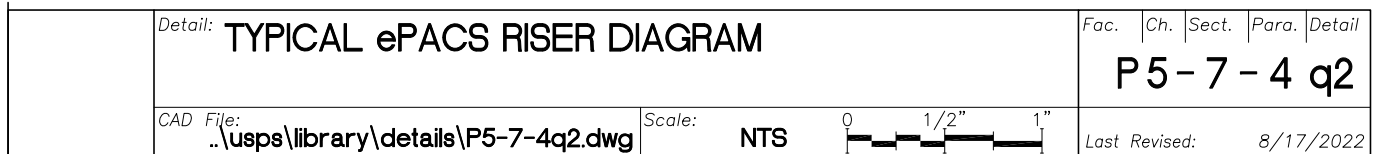
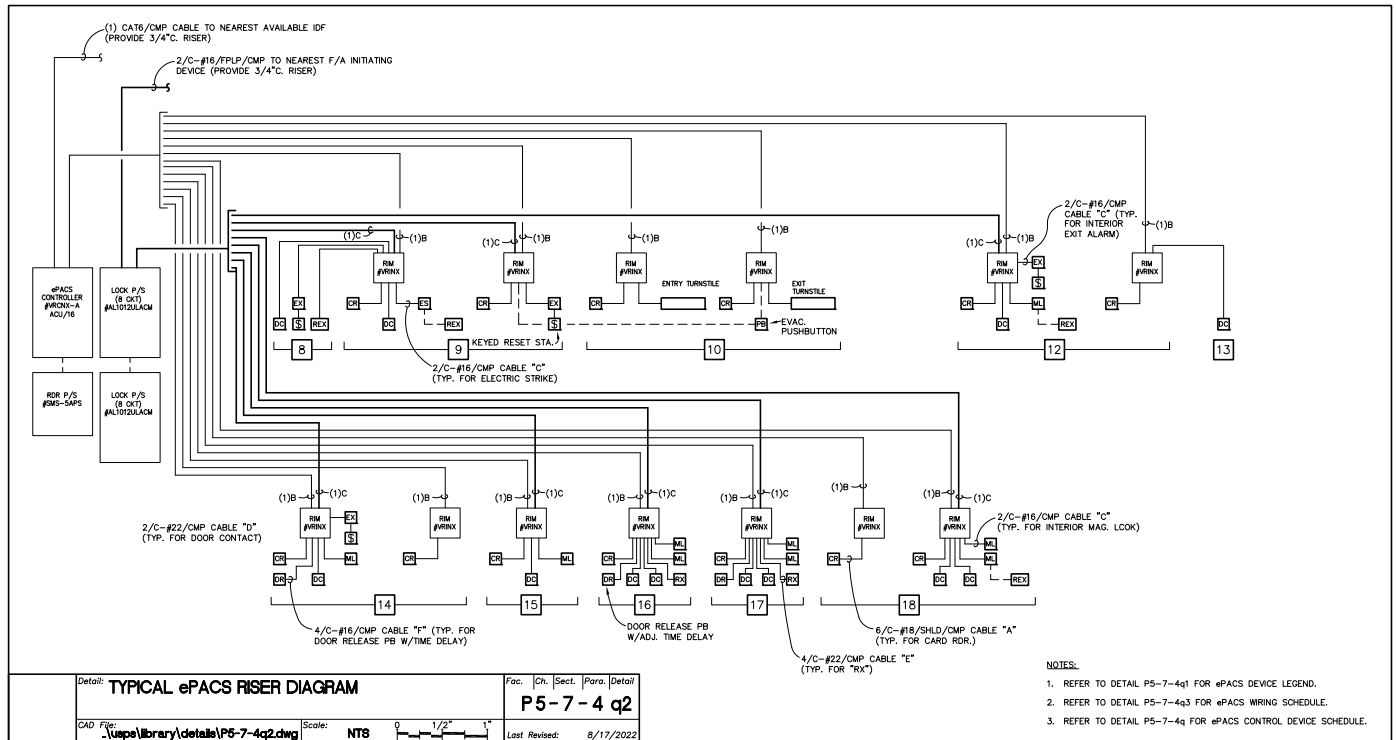

NOTES TO A/E:

ePACS WIRING SCHEDULE

TYPE	CABLE DESCRIPTION	MANUFACTURER *	USAGE
A	6/C-#18/SHLD/CMP WHITE (0.228" O.D.; 0.040828 IN ²)	TAPPAN #SW57788802	RDR TO "RIM"
B	4/C-#18/SHLD/CMP WHITE (0.180" O.D.; 0.02545 IN ²)	TAPPAN #SW57788102	"RIM" TO CONTROLLER
C	2/C-#16/CMP WHITE (0.178" O.D.; 0.02488 IN ²)	TAPPAN #P50032	ELECTRIC STRIKE/MAG LOCK TO "RIM", "EX" TO "RIM", "RIM" TO LOCK PWR SUPPLY
D	2/C-#22/CMP WHITE (0.111" O.D.; 0.0097 IN ²)	TAPPAN #SWP20031	DOOR CONTACT TO "RIM"
E	4/C-#22/CMP WHITE (0.128" O.D.; 0.0129 IN ²)	TAPPAN #SWP20035	"RX" TO "RIM"
F	4/C-#16/CMP WHITE (0.210" O.D.; 0.03464 IN ²)	TAPPAN #SWP50059	DOOR RELEASE PUSHBUTTON
G	6/C-#18/SHLD/WET BLACK (0.291" O.D.; 0.0665 IN ²)	TAPPAN #SW1880 AB6M/VNPVC	EXTERIOR LRCR TO "RIM"
H	2/C-#18/WET BLACK (0.266" O.D.; 0.0556 IN ²)	TAPPAN #U49995	EXTERIOR GATE CONTROLLER TO "RIM"
I	NOT USED	-	-
J	4/C-#18/SHLD/OSP/WET/BLACK (0.29" O.D.; 0.0665 IN ²)	TAPPAN #SW4028	EXTERIOR "RIM" TO CONTROLLER
K	2/C-#16/SHLD/WET BLACK (0.178" O.D.; 0.0249 IN ²)	TAPPAN #P50002	EXTERIOR "MAG. LOCK" TO "RIM"
L	2/C-#22/SHLD/WET BLACK (0.148" O.D.; 0.01720 IN ²)	TAPPAN #SW2033	EXTERIOR "DOOR CONTACT" TO "RIM"

* THE FOLLOWING U.S. CABLE MANUFACTURERS OFFERING EQUAL PRODUCT ARE ACCEPTABLE:
 TAPPAN/SOUTHWIRE
 BELDEN
 COMMSCOPE
 MOHAWK/CDT
 WEST PENN

Detail: **ePACS WIRING SCHEDULE**

Fac.	Ch.	Sect.	Para.	Detail
				P5-7-4 q3

CAD File: ..\usps\library\details\P5-7-q3.dwg

Scale: **NTS**

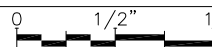

Last Revised: 8/30/2021



STANDARD DETAIL LIBRARY

NOTES TO A/E:

1. THE BASIS OF DESIGN FOR THIS VIDEO INTERCOM SYSTEM IS THE AIPHONE "X" SERIES". TYPICALLY, CAT 6 WIRING IS UTILIZED FOR INTERFACING OF THE DOOR CALL-IN AND MULTIPLE MASTER STATIONS TO THE NETWORK NODE CABINET. CAT 6 INTERFACE WIRING IS LIMITED TO A MAXIMUM LENGTH OF 330 FT. THE NETWORK NODE CABINET SHALL THEREFORE BE CENTRALLY LOCATED BETWEEN THE MASTER AND DOOR STATIONS TO AVOID EXCESSIVELY LONG CABLE RUNS. MASTER AND CALL STATIONS LOCATED MORE THAN 330 FT. FROM THE NETWORK NODE CABINET SHALL UTILIZE FIBER CABLING, FIBER PATCH PANELS AND FIBER TRANSMITTERS/RECEIVERS. APPLICATIONS REQUIRING A LARGE QUANTITY OF FIBER CABLES MAY REQUIRE ADDITIONAL, STRATEGICALLY LOCATED, NETWORK NODE CABINETS TO PERMIT THE USE OF CAT 6 CABLING AND AVOID THE EXCESSIVE FIBER CABLING.
2. THIS RISER DIAGRAM IS INTENDED TO BE USED AS A GUIDE TO THE PROJECT ENGR.. THE RISER DIAGRAM SHALL BE MODIFIED TO SUITE SPECIFIC PROJECT REQUIREMENTS; QUANTITIES OF CALL STAS., MASTER STAS. AND GATE/DOOR RELEASES ARE PROJECT SPECIFIC.
3. SURGE PROTECTION MODULES (SPD'S) SHALL BE PROVIDED ON EACH END OF ALL EXTERIOR CAT 6 & LOW VOLTAGE CABLE RUNS. SPD'S ARE ALSO REQUIRED UPON CABLING ENTERING OR EXITING THE BUILDING.

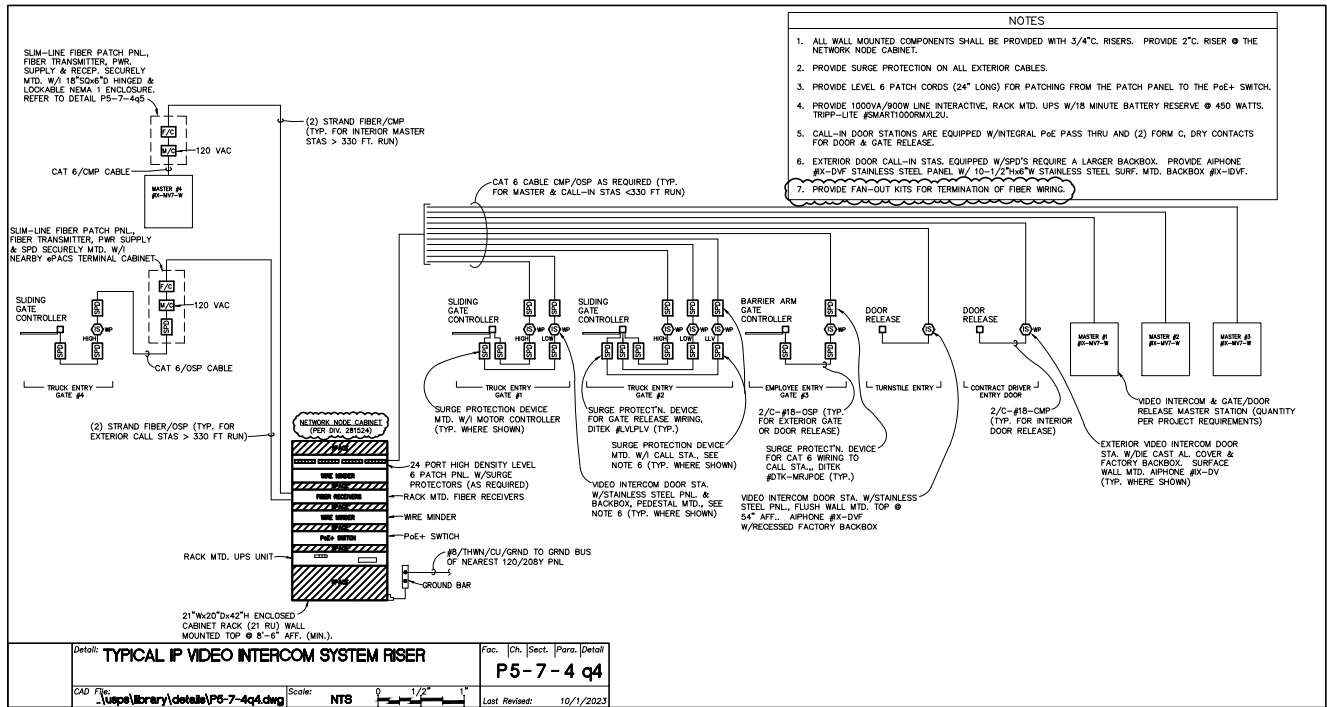

Detail:	TYPICAL IP VIDEO INTERCOM SYSTEM RISER	Fac.	Ch.	Sect.	Para.	Detail
						P5-7-4 q4
CAD File:	..\\usps\library\details\P5-7-4q4.dwg	Scale:	NTS	0 1/2\" 1\"		Last Revised: 10/1/2023



NOTES TO A/E:

1. REFER TO TYPICAL IP VIDEO INTERCOM SYSTEM RISER P5-7-4q4.

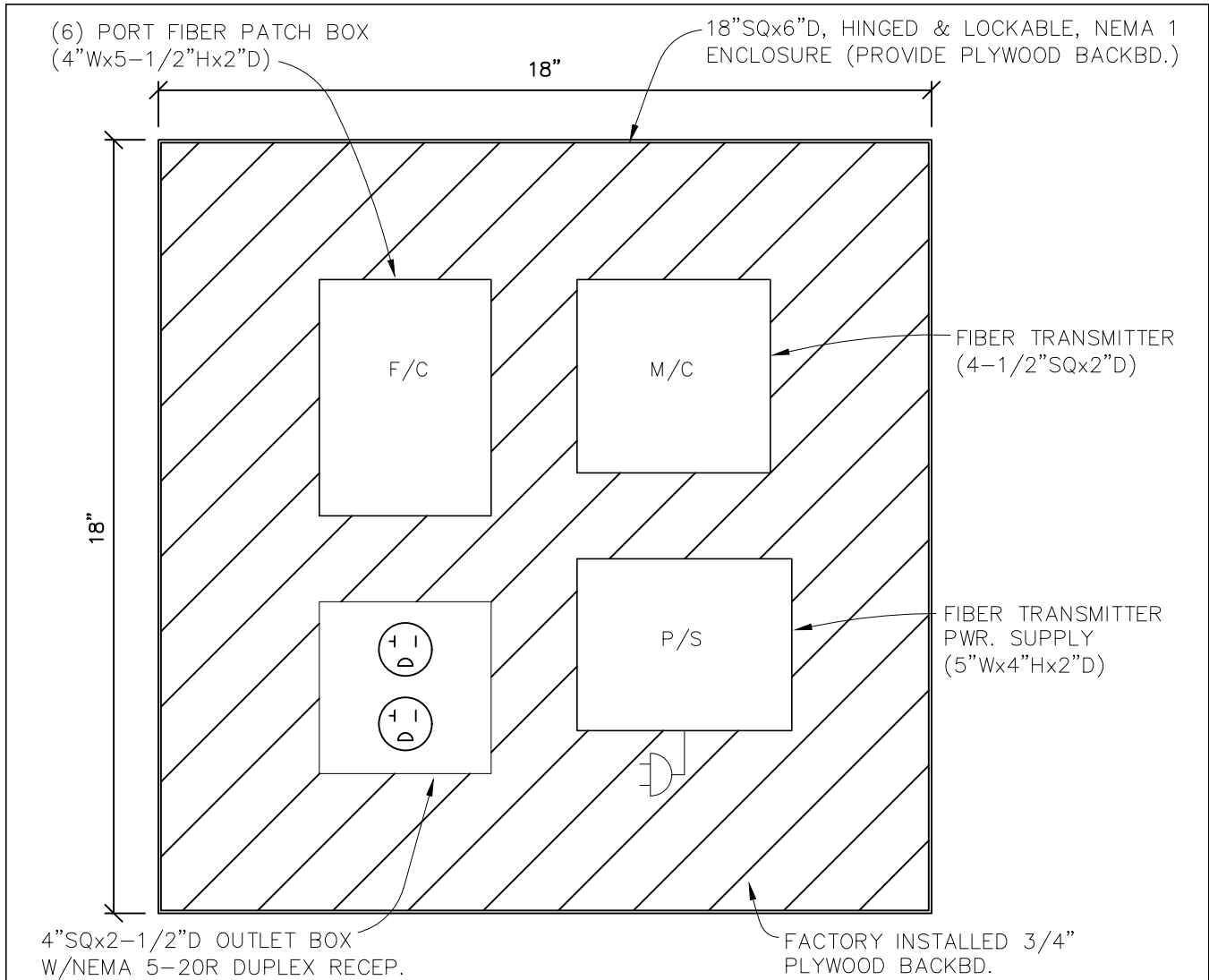

NOTES:

1. ALL COMPONENTS SHALL BE SECURELY FASTENED TO THE BACKBOARD USING FACTORY BRACKETS & APPROPRIATE WOOD SCREWS. USE OF DOUBLE SIDED, ADHESIVE HOOK & LOOP STRAPS IS NOT ACCEPTABLE.
2. PROVIDE 2 FT. LONG, CONDUIT SLEEVES EQUIPPED W/BUSHINGS TO PROTECT OPEN CABLING ENTERING THE ENCLOSURE.
3. PATCH CORDS SHALL BE AS LONG AS NECESSARY FOR THE APPLICATION BUT AS SHORT AS POSSIBLE TO AVOID LARGE CABLE BUNDLES.
4. EXCESS CABLE LENGTHS SHALL BE PROPERLY LOOPED AND SECURED USING HOOK & LOOP STRAPS; TIE-WRAPPS ARE NOT ACCEPTABLE.
5. THE 120 VOLT WIRING ROUTED W/I THE ENCLOSURE SHALL BE CONTAINED IN CONDUIT. OPEN 120 VOLT WIRING IS NOT ACCEPTABLE.
6. A 20 FT. FIBER OPTIC SERVICE LOOP SHALL BE INSTALLED OUTSIDE THE ENCLOSURE. SERVICE LOOP SHALL BE INSTALLED SUCH THAT THE MINIMUM BEND RADIUS IS NOT EXCEEDED. ONCE THE FIBER REACHES THE PATCH PANEL THERE SHALL BE NO LESS THAN 3 FEET OF UNSHEATHED FIBER INSTALLED NEATLY IN STORAGE TRAY PRIOR TO INSTALLATION OF FAN-OUT KITS AND TERMINATIONS.

Detail: **TYPICAL INTERIOR VIDEO INTERCOM
FIBER ENCLOSURE**

Fac. | Ch. | Sect. | Para. | Detail
P5-7-4 q5

CAD File: \\12 standard details\details\P5-7-0e1.dwg

Scale: **3" = 1'-0"**

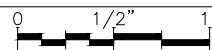

Last Revised: 10/1/2023

NOTES TO A/E:

1. PROVIDE ELECTRO MAGNETIC LOCKS & SURFACE MOUNTED DOOR CONTACT FOR EXISTING DOORS NOT PRESENTLY EQUIPPED WITH ePACS DEVICES.

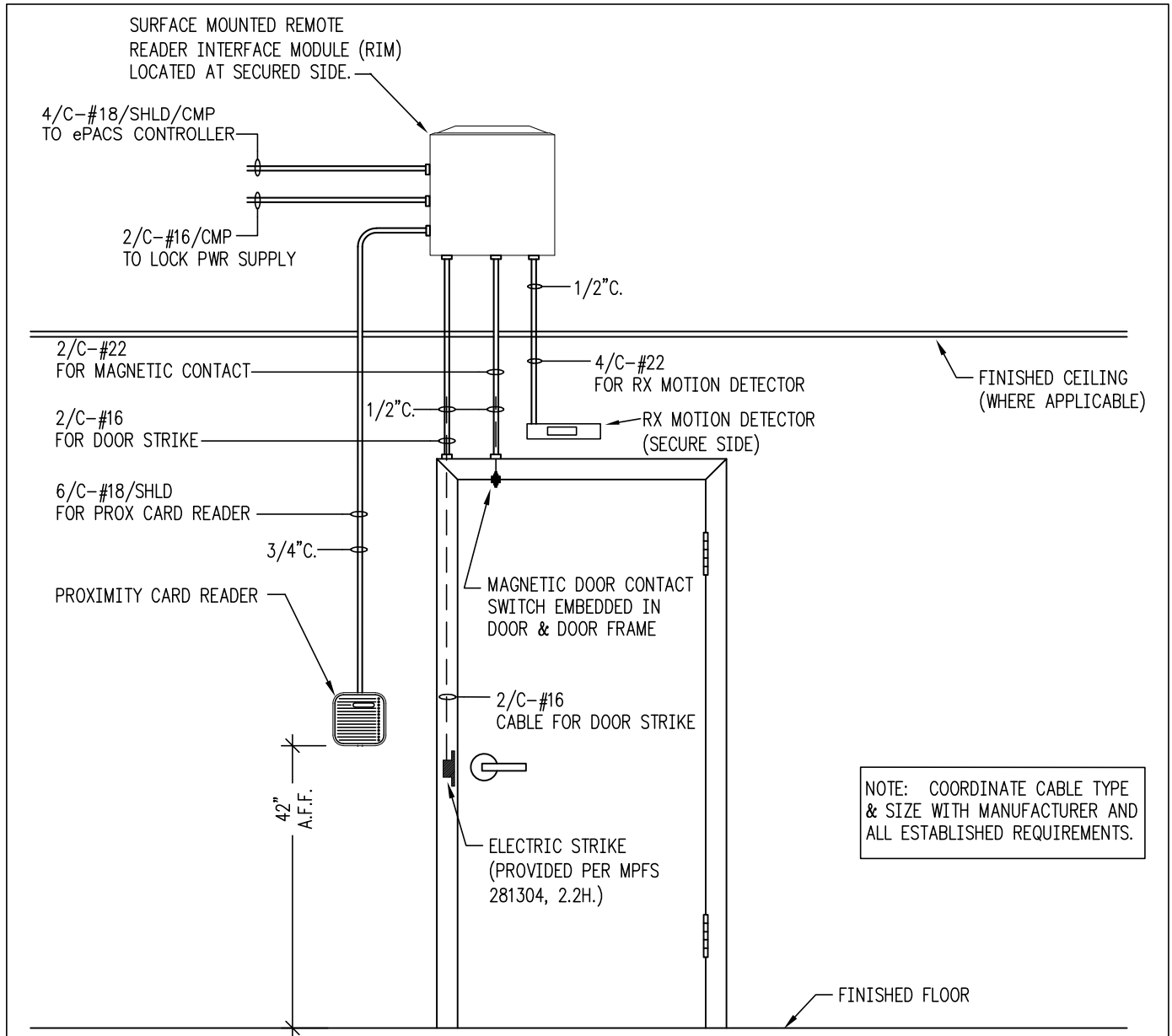

NOTE: COORDINATE CABLE TYPE & SIZE WITH MANUFACTURER AND ALL ESTABLISHED REQUIREMENTS.

NOTE:

1. REFER TO TYPICAL ePACS RELATED DETAILS P5-7-4q THRU P5-7-4q3.

Detail:	TYPICAL CARD READER - SINGLE DOOR CONFIGURATION				Fac.	Ch.	Sect.	Para.	Detail	
					P5-7-4r					
CAD File:	..\\usps\\library\\details\\P5-7-r.dwg			Scale:	NTS		0 1/2" 1"		Last Revised:	8/10/2020

NOTES TO A/E:

1. PROVIDE ELECTRO MAGNETIC LOCK, ELECTRO MECHANICAL PANIC PUSHBAR (TO DEACTIVATE THE MAG. LOCK) & SURFACE MOUNTED DOOR CONTACT FOR EXISTING DOORS NOT PRESENTLY EQUIPPED WITH ePACS DEVICES.
2. EXIT DOOR ALARM SHALL BE 12 VDC, FED FROM THE LOCK PWR. SUPPLY AND PROVIDED PER MPFS 281304, ¶2.2L.. STAND-ALONE 120V. ALARMS SHALL NOT BE UTILIZED WHERE THE DOOR IS EQUIPPED WITH ePACS DEVICES.
3. ELECTRIC STRIKES SHALL BE EQUIPPED FOR "FREE EXIT". UNAUTHORIZED EGRESS (WITHOUT USE OF CARD READER TO DISABLE THE DOOR CONTACT) SHALL CAUSE THE EXIT ALARM TO ACTIVATE.

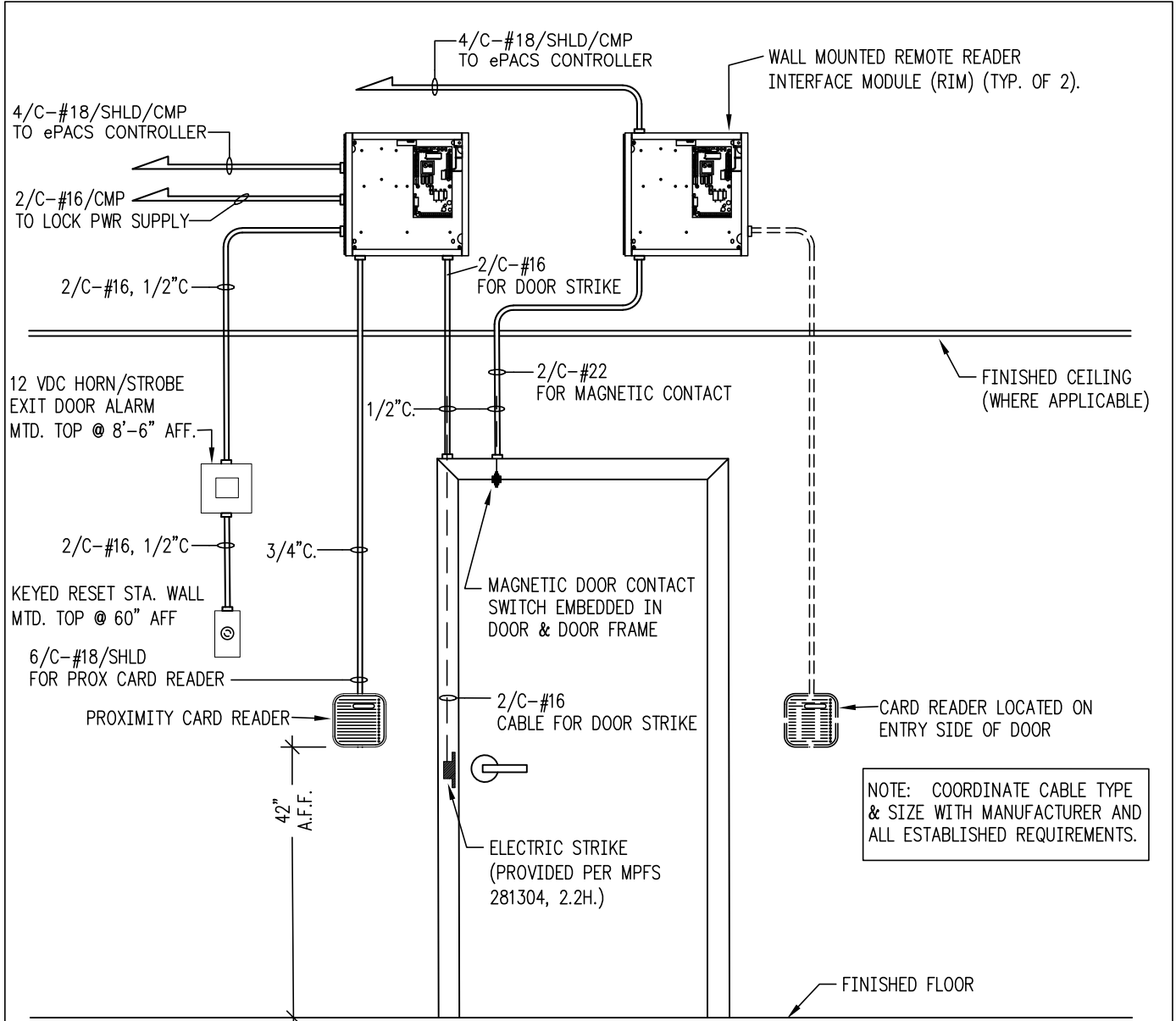

NOTE:

1. REFER TO TYPICAL ePACS RELATED DETAILS P5-7-4q THRU P5-7-4q3.
2. DETAIL IS DRAWN VIEWING THE DOOR FROM THE EGRESS SIDE.
3. EXIT DOOR ALARM SHALL BE INSTALLED DIRECTLY OVER OR ADJACENT TO THE DOOR.

Detail:	TYPICAL DUAL CARD READERS - SINGLE DOOR CONFIGURATION				Fac.	Ch.	Sect.	Para.	Detail	
					P5-7-4 r1					
CAD File:	..\\usps\\library\\details\\P5-7-r2.dwg			Scale:	NTS		0 1/2" 1"		Last Revised:	10/1/2020

NOTES TO A/E:

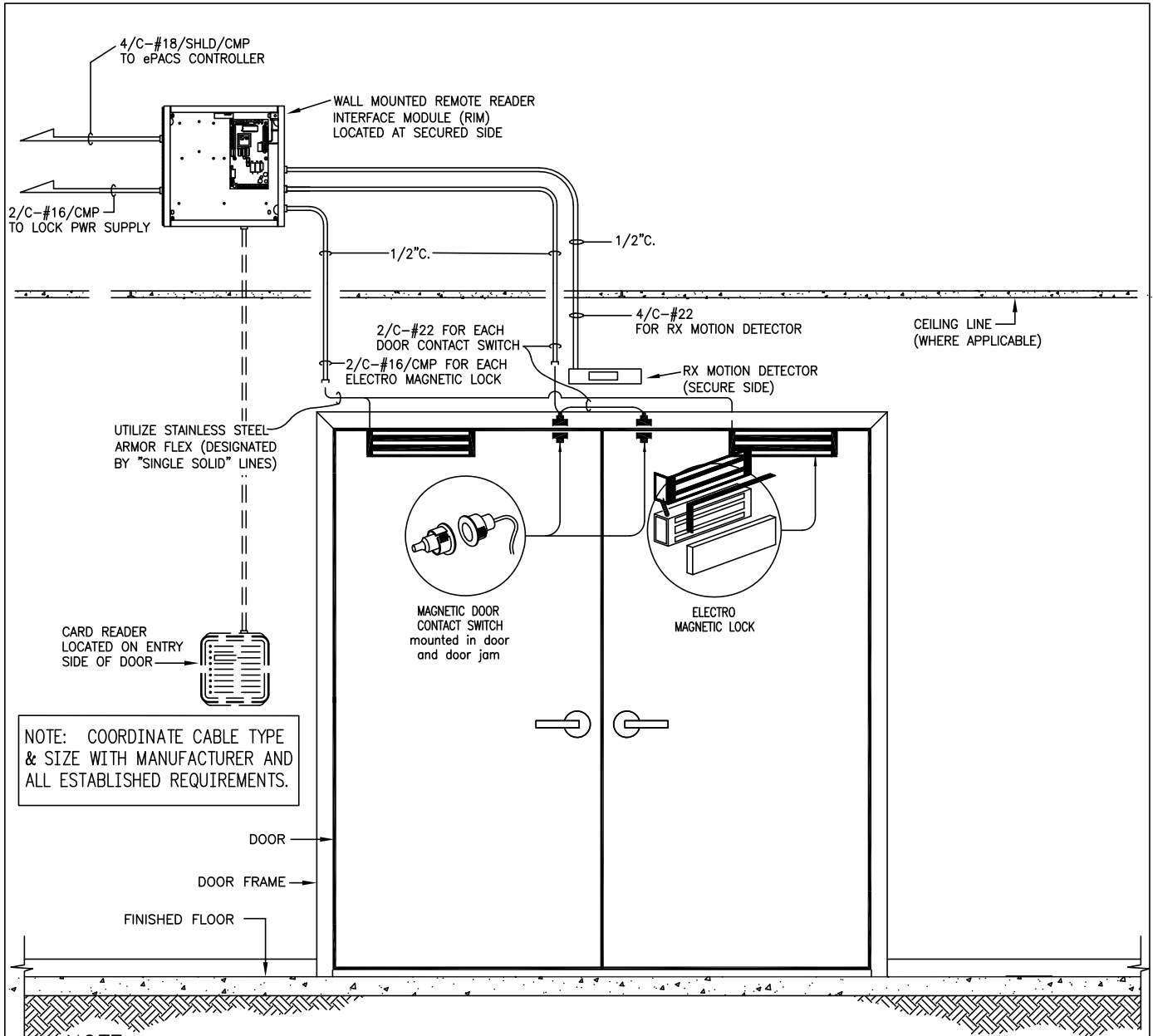

NOTE:

1. REFER TO TYPICAL ePACS RELATED DETAILS P5-7-4q THRU P5-7-4q3.
2. DETAIL IS DRAWN VIEWING THE DOOR FROM THE EGRESS SIDE.

Detail:	TYPICAL SINGLE CARD READER - DOUBLE DOOR CONFIGURATION				Fac.	Ch.	Sect.	Para.	Detail	
					P5-7-4 r2					
CAD File:	..\\usps\\library\\details\\P5-7-r1.dwg			Scale:	NTS		0 1/2" 1"		Last Revised:	10/1/2020

NOTES TO A/E:

- EXIT DOOR ALARM SHALL BE 12 VDC, FED FROM THE LOCK PWR. SUPPLY AND PROVIDED PER MPFS 281304, ¶2.2L.. STAND-ALONE 120V. ALARMS SHALL NOT BE UTILIZED WHERE THE DOOR IS EQUIPPED WITH ePACS DEVICES.

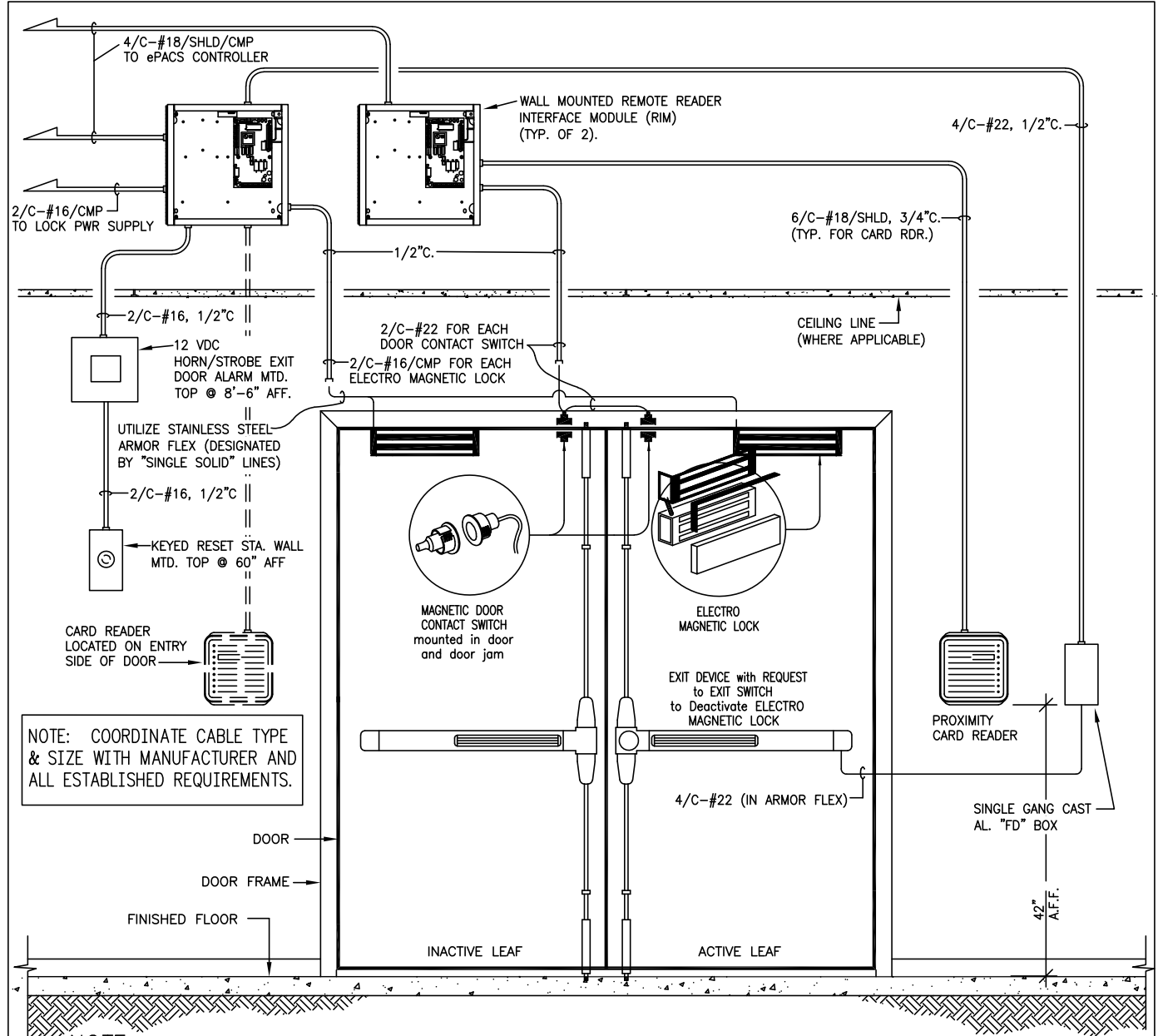

NOTE: COORDINATE CABLE TYPE & SIZE WITH MANUFACTURER AND ALL ESTABLISHED REQUIREMENTS.

NOTE:

- REFER TO TYPICAL ePACS RELATED DETAILS P5-7-4q THRU P5-7-4q3.
- DETAIL IS DRAWN VIEWING THE DOOR FROM THE EGRESS SIDE.
- EXIT DOOR ALARM SHALL BE INSTALLED DIRECTLY OVER OR ADJACENT TO THE DOOR.

Detail:	TYPICAL DUAL CARD READERS - DOUBLE DOOR CONFIGURATION				Fac.	Ch.	Sept.	Para.	Detail
					P5-7-4 r3				
CAD File:	..\\usps\\library\\details\\P5-7-r1.dwg		Scale:	NTS	0 1/2" 1"		Last Revised: 7/22/2020		

NOTES TO A/E:

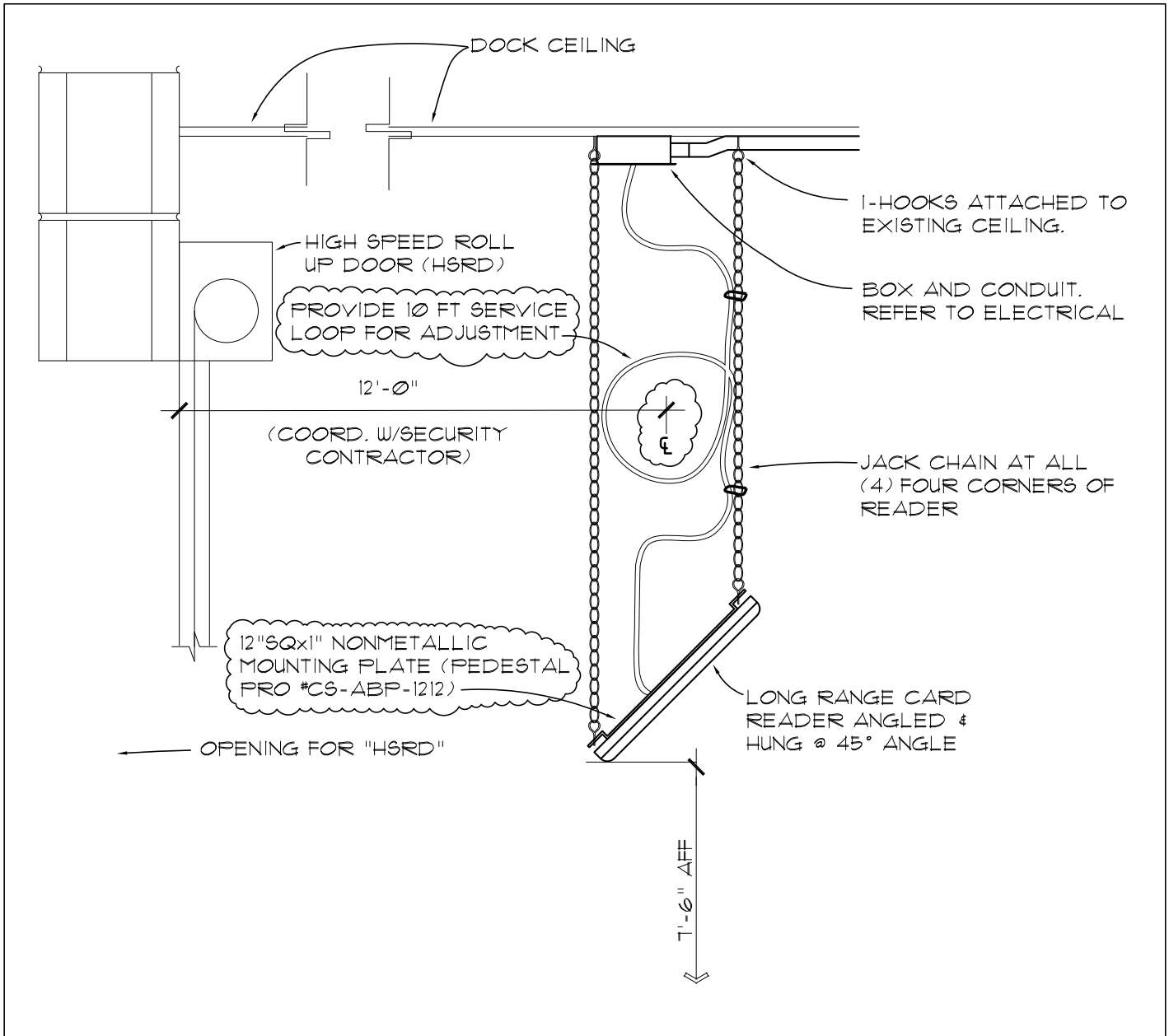

Detail: TYPICAL LONG RANGE CARD READER AT HSRD - MOUNTING DETAIL	Fac. Ch. Sect. Para. Detail
	P5-7-4 s
CAD File: \usps\library\details\P5-7-4s.dwg	Scale: NTS 0 1/2" 1"
Last Revised:	8/31/2022

NOTES TO A/E:

1. PROVIDE PANIC HARDWARE AND DOOR ALARMS FOR EXIT DOORS AS INDICATED IN MPFDC 1 SECTION 2-7.2.2 AND MPFDC 1 SECTION 5-7.6.
2. ELECTRIC STRIKES (ES) ARE THE PREFERRED METHOD OF CONTROLLING NEW SINGLE LEAF DOORS.
3. THE CARD READER (USED FOR FOOT TRAFFIC) AND THE HANGING LONG RANGE CARD READER CONTROLLING THE TRAFFIC FLOW FROM THE WORKROOM INTO THE PLATFORM ARE ONLY REQUIRED FOR "OPEN" MAIL PLATFORMS. THESE CARD RDRS MAY NOT BE REQUIRED FOR FACILITIES WITH "ENCLOSED" MAIL PLATFORMS. COORD. SPECIFIC PROJECT REQUIREMENTS WITH THE LOCAL USPIS AND OIG.
4. THE PREFERRED MOUNTING OF THE CARD RDRS USED FOR FOOT TRAFFIC IS WALL MOUNTED TOP @ 44" AFF.. A PEDESTAL MOUNTED CARD RDR CAN BE UTILIZED WHERE AMPLE WALL SPACE IS NOT AVAILABLE FOR WALL MOUNTING.

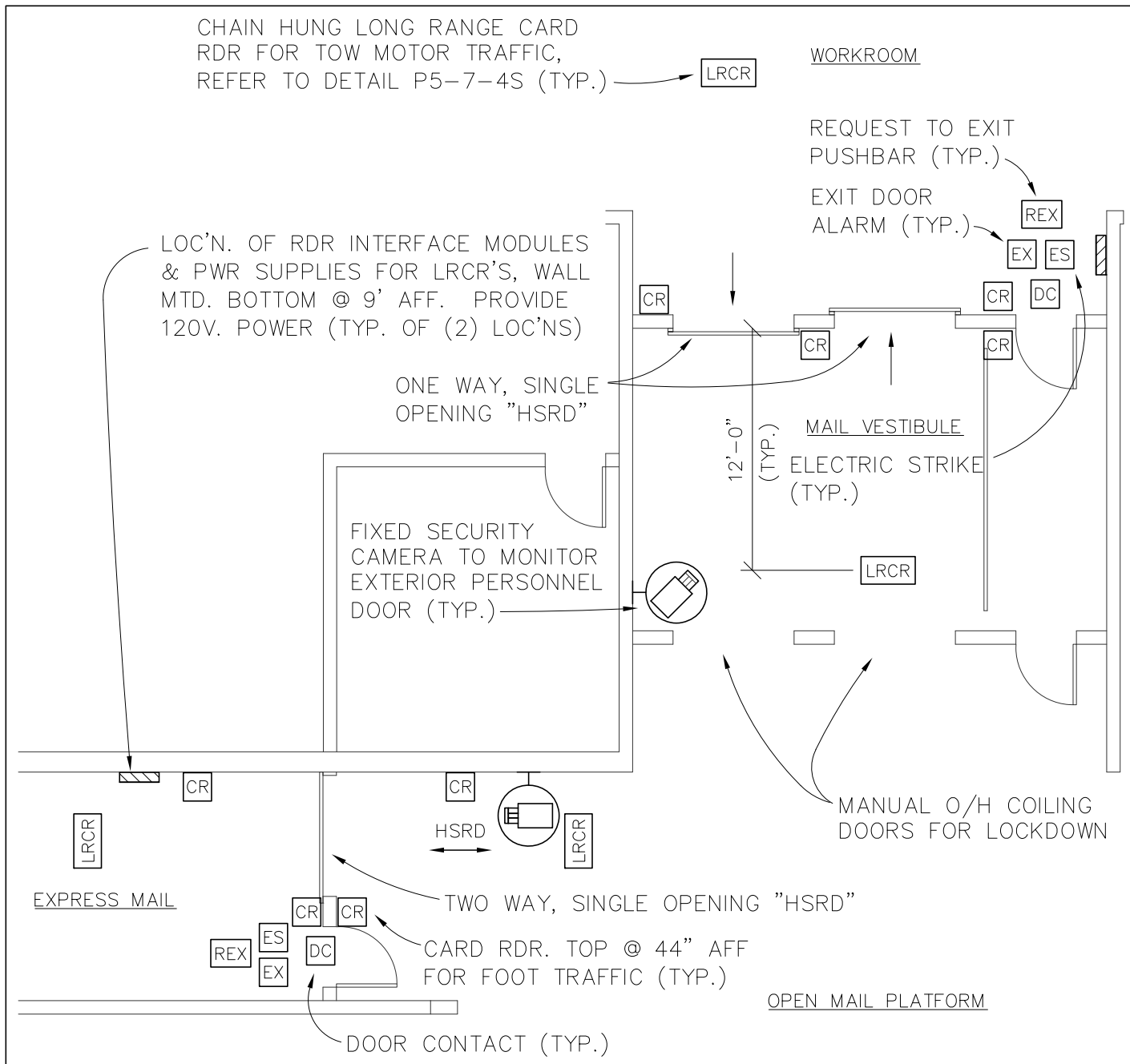

Detail:	ePACS - HIGH SPEED ROLLUP DOOR "HSRD" (NEW)				Fac.	Ch.	Sect.	Para.	Detail	
					P5-7-4s1					
CAD File:	12 standard details\details\P5-7-4s1.dwg			Scale:	1/8" = 1'-0"		0 1/2" 1"		Last Revised:	10/1/2019

NOTES TO A/E:

1. PROVIDE PANIC HARDWARE AND DOOR ALARMS FOR EXIT DOORS AS INDICATED IN MPFDC 1 SECTION 2-7.2.2 AND MPFDC 1 SECTION 5-7.6.
2. EXISTING DOORS NOT PRESENTLY EQUIPPED W/ELECTRIC STRIKES SHALL UTILIZE ELECTROMAGNETIC (ML) STYLE LOCKS AS SHOWN.
3. THE CARD READER (USED FOR FOOT TRAFFIC) AND THE HANGING LONG RANGE CARD READER CONTROLLING THE TRAFFIC FLOW FROM THE WORKROOM INTO THE PLATFORM ARE ONLY REQUIRED FOR "OPEN" MAIL PLATFORMS. THESE CARD RDRS MAY NOT BE REQUIRED FOR FACILITIES WITH "ENCLOSED" MAIL PLATFORMS. COORD. SPECIFIC PROJECT REQUIREMENTS WITH THE LOCAL USPIS AND OIG.
4. THE PREFERRED MOUNTING OF THE CARD RDRS USED FOR FOOT TRAFFIC IS WALL MOUNTED TOP @ 44" AFF.. A PEDESTAL MOUNTED CARD RDR CAN BE UTILIZED WHERE AMPLE WALL SPACE IS NOT AVAILABLE FOR WALL MOUNTING.

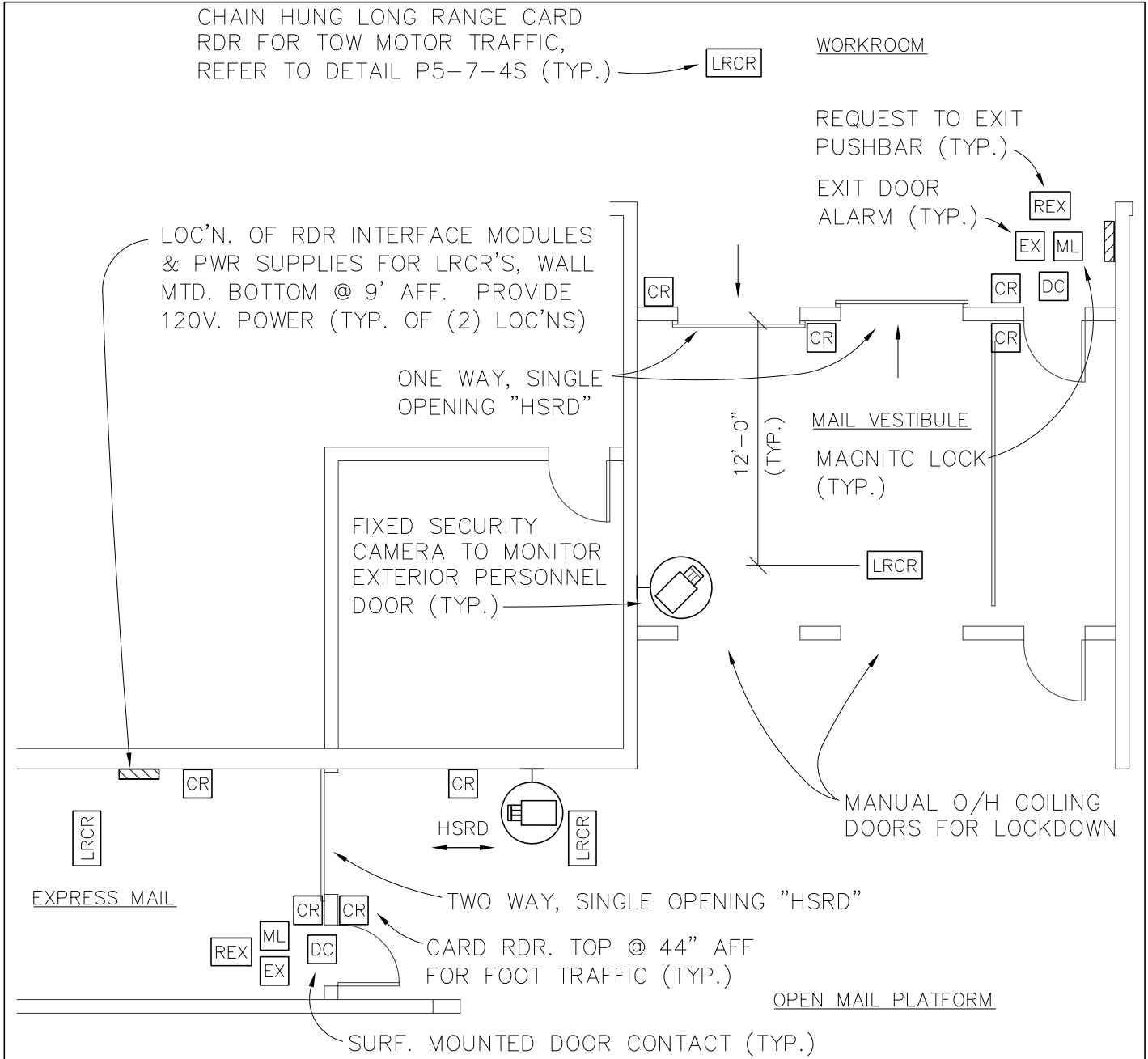

Detail:	ePACS - HIGH SPEED ROLLUP DOOR "HSRD" (EXISTING)				Fac.	Ch.	Sect.	Para.	Detail	
					P5-7-4s2					
CAD File:	\12 standard details\details\P5-7-4s2.dwg			Scale:	1/8" = 1'-0"		0 1/2" 1"		Last Revised:	10/1/2019

NOTES TO A/E:

1. PROVIDE PANIC HARDWARE AND DOOR ALARMS FOR EXIT DOORS AS INDICATED IN MPFDC 1 SECTION 2-7.2.2 AND MPFDC 1 SECTION 5-7.6.
2. ELECTRIC STRIKES (ES) ARE THE PREFERRED METHOD OF CONTROLLING NEW SINGLE LEAF DOORS.
3. ALL DOUBLE LEAFED DOORS (NEW OR EXIST'G.) SHALL BE PROVIDED WITH (2) MAG LOCKS. PROVIDE SURF. MTD. DOOR CONTACTS FOR EXIST'G. DOUBLE LEAF DOORS.

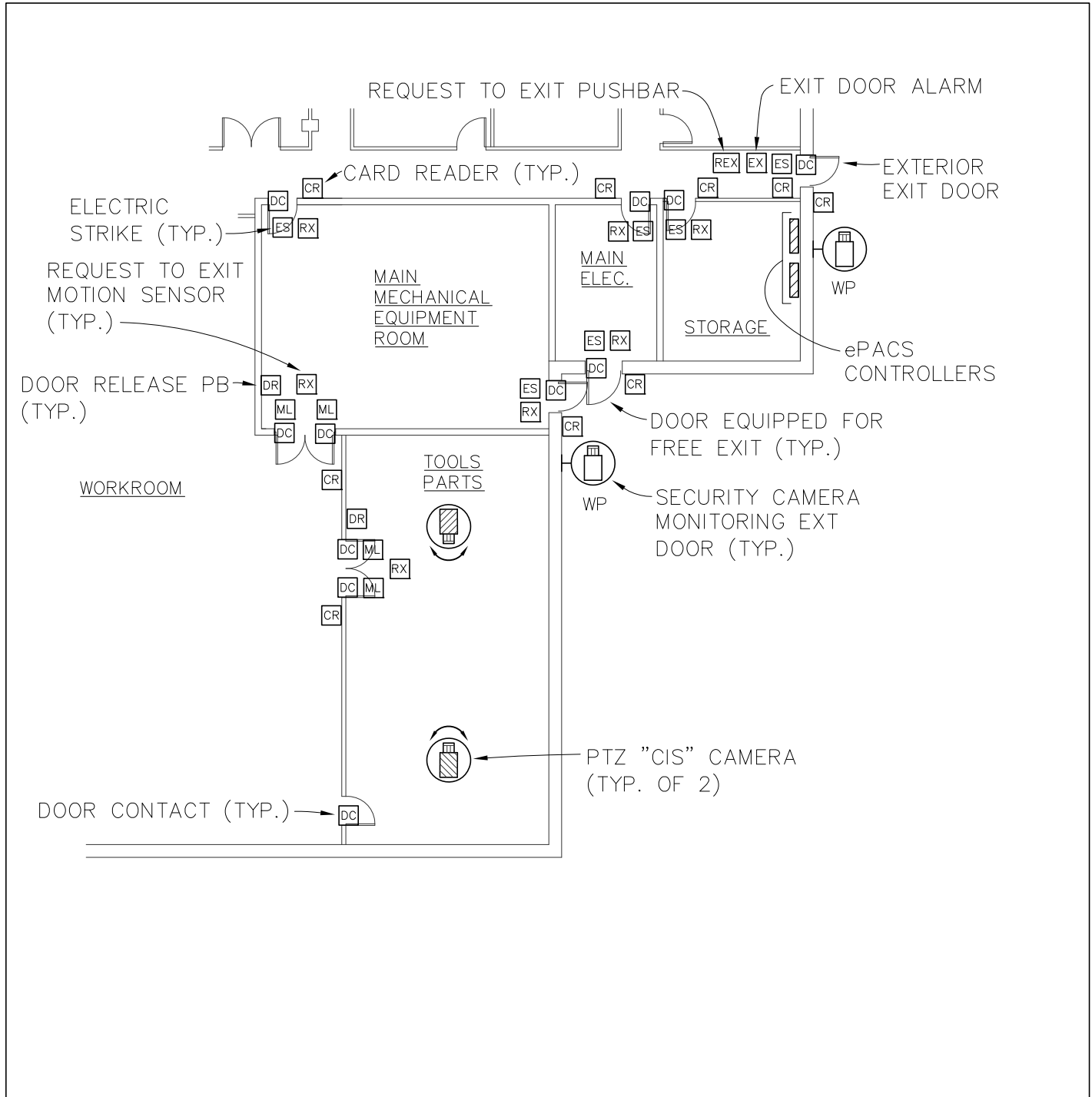

Detail: ePACS - EQUIPMENT AND TOOL AND PARTS STORAGE ROOMS (NEW)	Fac. Ch. Sect. Para. Detail P5-7-4t
	CAD File: \12 standard details\details\P5-7-4t.dwg Scale: 1/16" = 1'-0"

NOTES TO A/E:

1. PROVIDE PANIC HARDWARE AND DOOR ALARMS FOR EXIT DOORS AS INDICATED IN MPFDC 1 SECTION 2-7.2.2 AND MPFDC 1 SECTION 5-7.6.
2. EXISTING SINGLE LEAF DOORS NOT PRESENTLY EQUIPPED W/ELECTRIC STRIKES SHALL UTILIZE ELECTROMAGNETIC (ML) STYLE LOCKS AS SHOWN.

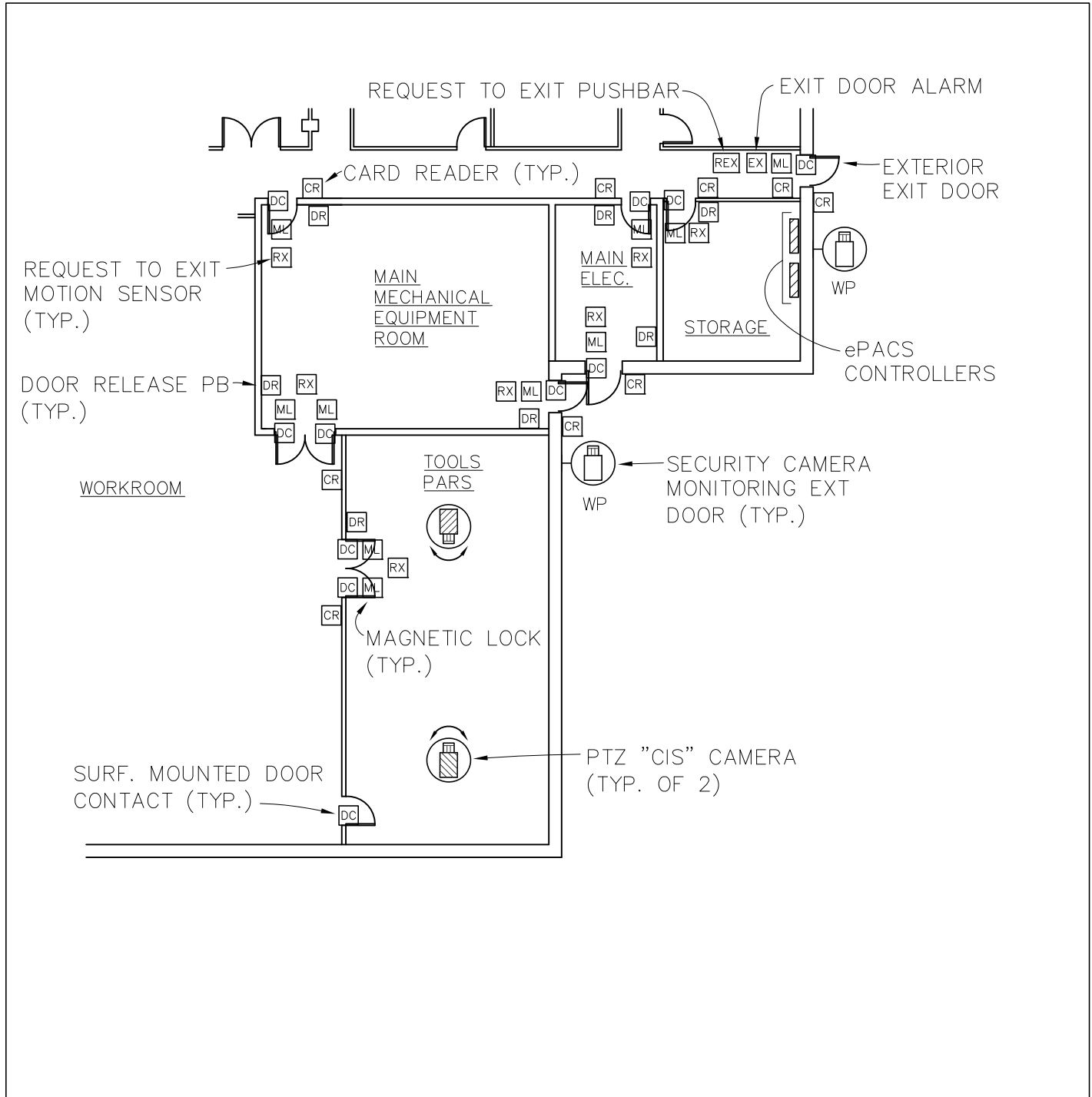

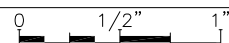
Detail: ePACS - EQUIPMENT AND TOOL AND PARTS STORAGE ROOMS (EXISTING)	Fac. Ch. Sect. Para. Detail P5-7-4 t1
	CAD File: \\12 standard details\details\P5-7-4t1.dwg Scale: 1/16" = 1'-0" 

NOTES TO A/E:

1. PROVIDE PANIC HARDWARE AND DOOR ALARMS FOR EXIT DOORS AS INDICATED IN MPFDC 1 SECTION 2-7.2.2 AND MPFDC 1 SECTION 5-7.6.
2. ELECTRIC STRIKES (ES) ARE THE PREFERRED METHOD OF CONTROLLING NEW SINGLE LEAF DOORS.
3. ALL DOUBLE LEAFED DOORS (NEW OR EXIST'G.) SHALL BE PROVIDED WITH (2) MAG LOCKS. PROVIDE SURF. MTD. DOOR CONTACTS FOR EXIST'G. DOUBLE LEAF DOORS.

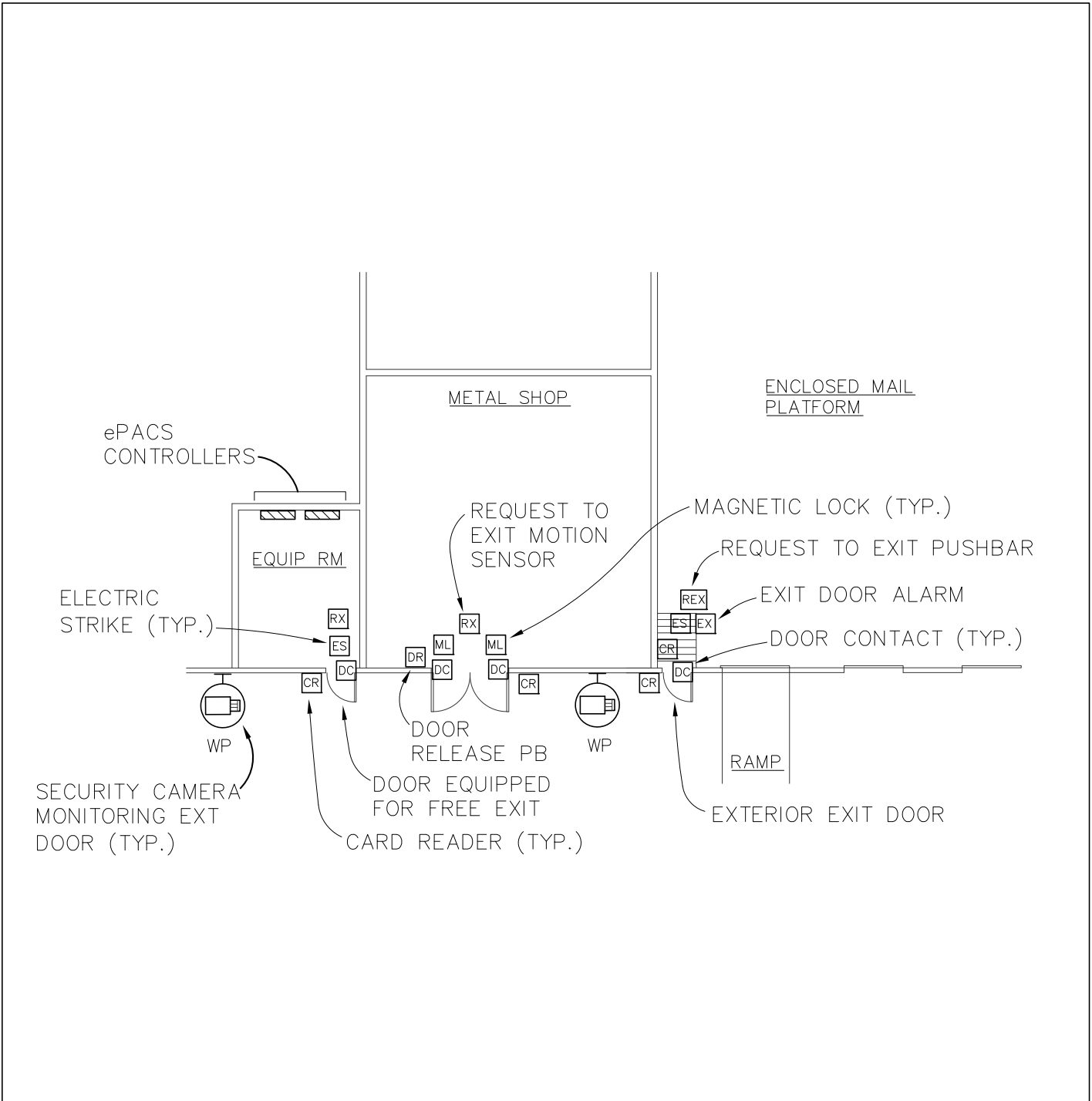

Detail: ePACS - EXTERIOR DOORS (NEW)		Fac.	Ch.	Sect.	Para.	Detail
		P5-7-4u				
CAD File: \\12 standard details\details\P5-7-4u.dwg		Scale: 1/16" = 1'-0"				
		Last Revised:		10/1/2019		

NOTES TO A/E:

1. PROVIDE PANIC HARDWARE AND DOOR ALARMS FOR EXIT DOORS AS INDICATED IN MPFDC 1 SECTION 2-7.2.2 AND MPFDC 1 SECTION 5-7.6.
2. EXISTING SINGLE LEAF DOORS NOT PRESENTLY EQUIPPED W/ELECTRIC STRIKES SHALL UTILIZE ELECTROMAGNETIC (ML) STYLE LOCKS AS SHOWN.

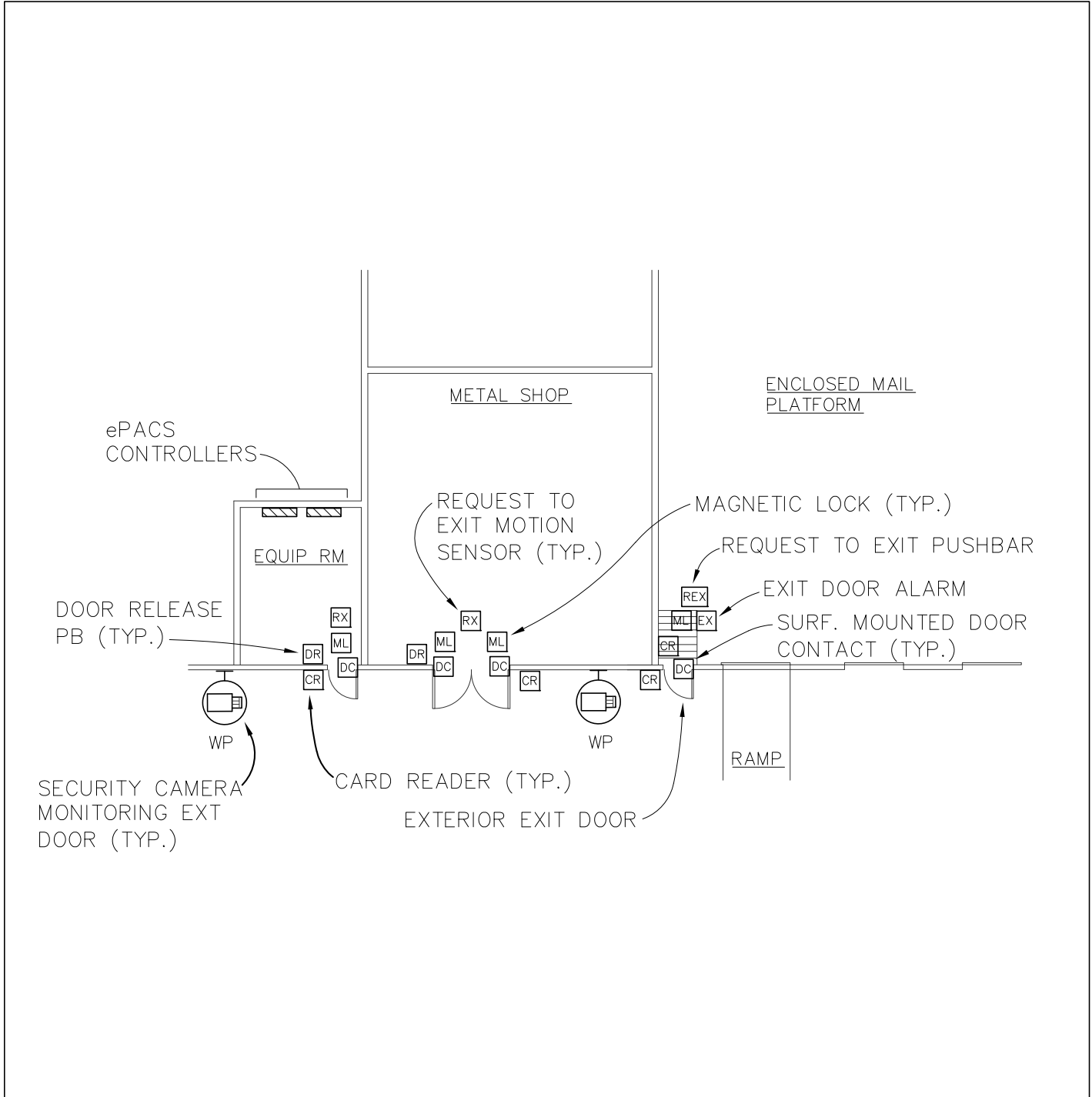

Detail: ePACS - EXTERIOR DOORS (EXISTING)	Fac. Ch. Sect. Para. Detail P5-7-4u1
	CAD File: \\12 standard details\details\P5-7-4u1.dwg Scale: 1/16" = 1'-0"
Last Revised: 10/1/2019	



STANDARD DETAIL LIBRARY

NOTES TO A/E:

1. PROVIDE PANIC HARDWARE AND DOOR ALARMS FOR EXIT DOORS AS INDICATED IN MPFDC 1 SECTION 2-7.2.2 AND MPFDC 1 SECTION 5-7.6.
2. ELECTRIC STRIKES (ES) ARE THE PREFERRED METHOD OF CONTROLLING NEW SINGLE LEAF DOORS.

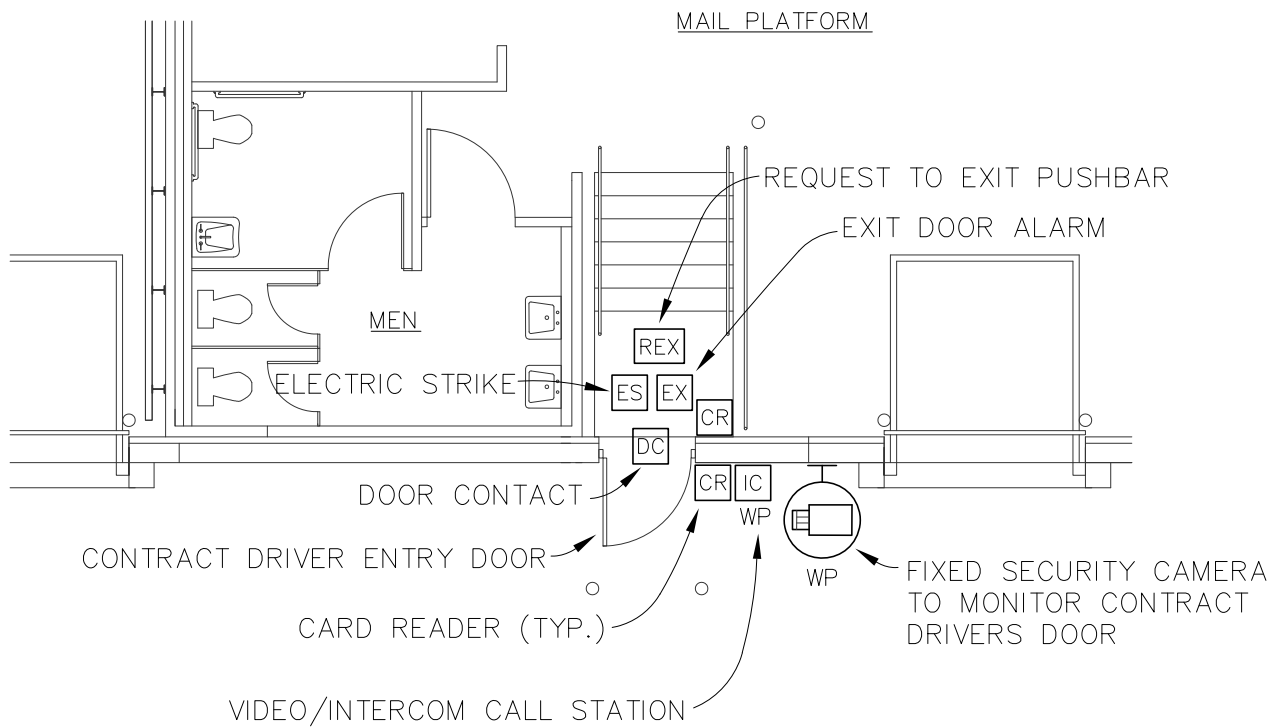

Detail: **ePACS - EXTERIOR CONTRACT DRIVER ENTRY (NEW)**

Fac.	Ch.	Sect.	Para.	Detail
				P5-7-4v

CAD File: \\12 standard details\details\P5-7-4v.dwg

Scale: 1/16" = 1'-0"

Last Revised: 10/1/2019

NOTES TO A/E:

1. PROVIDE PANIC HARDWARE AND DOOR ALARMS FOR EXIT DOORS AS INDICATED IN MPFDC 1 SECTION 2-7.2.2 AND MPFDC 1 SECTION 5-7.6.
2. EXISTING SINGLE LEAF DOORS NOT PRESENTLY EQUIPPED W/ELECTRIC STRIKES SHALL UTILIZE ELECTROMAGNETIC (ML) STYLE LOCKS AS SHOWN.

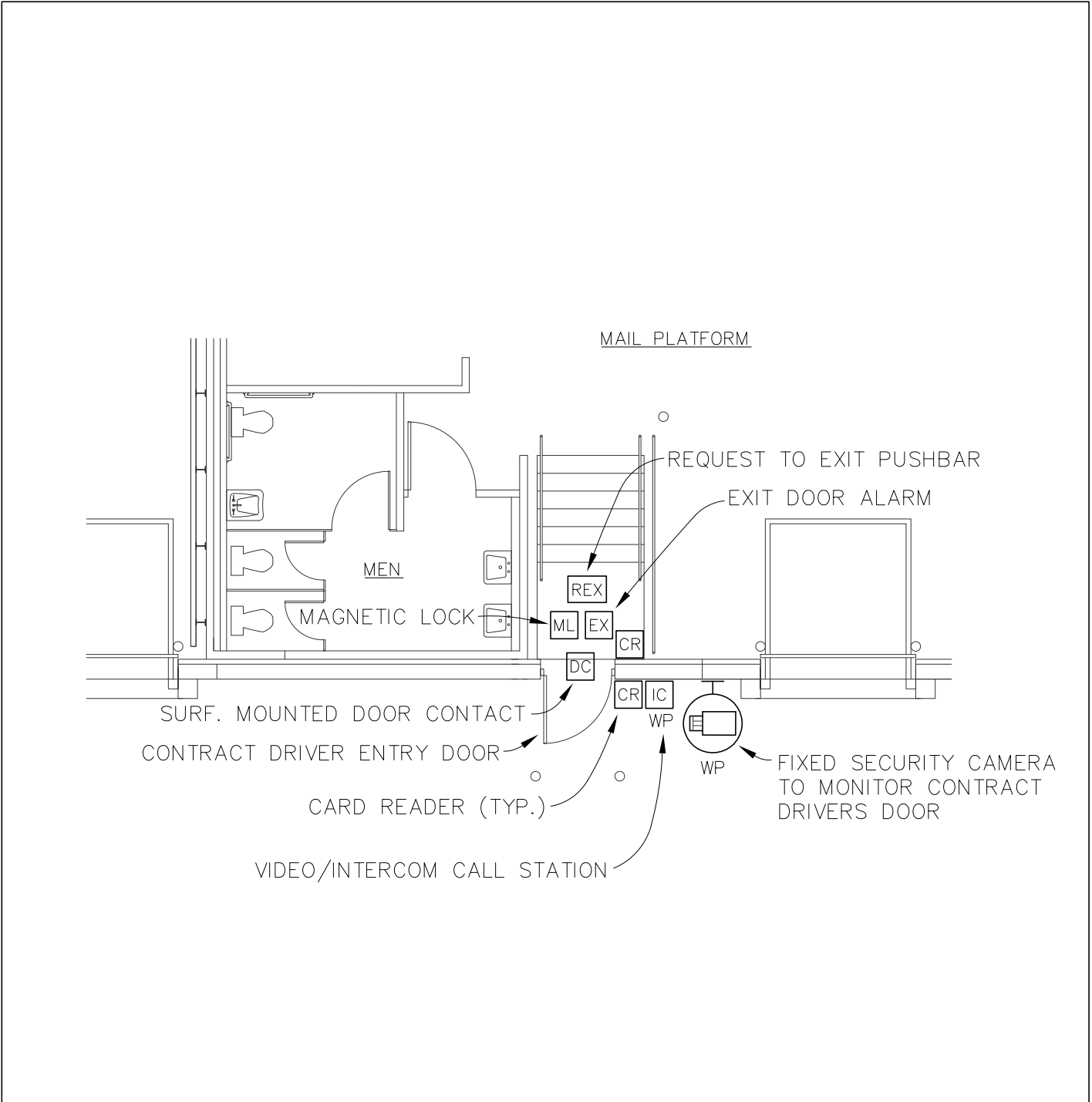

Detail: ePACS - EXTERIOR CONTRACT DRIVER ENTRY (EXISTING)	Fac. Ch. Sect. Para. Detail P5-7-4v1
	CAD File: \\12 standard details\details\P5-7-4v1.dwg Scale: 1/16" = 1'-0" 0 1/2" 1" Last Revised: 10/1/2019

NOTES TO A/E:

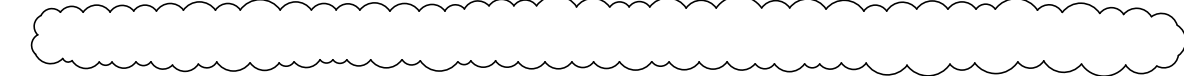

1. PROVIDE LIGHTING W/I THE INVESTIGATIVE OFFICE AS DIRECTED BY SDC MODULES 1 & 2A, SECTION 5-3.
2. COUNTER TOP WRITING SURFACE, REFER TO MPF STANDARD DETAIL P2-9-1c.

